



# TPC



**INNOVATION · RELIABILITY · QUALITY**  
*2019* **Catalog U.S.A**

# TPC

## OUR VISION

---

### *A Preferred Company*

To create a quality environment where people can work together to provide simple, creative solutions for the betterment of dentistry.

## OUR MISSION

---

### *Continuous Improvement*

We will manufacture innovative, high quality and cost effective dental products that enable distribution partners, dentists, hygienists, teaching institutions and government organizations throughout the world to perform efficient quality dental care. TPC provides innovative solutions and quality equipment that enables dental professionals to work together for the benefit of dentistry.

## TABLE OF CONTENTS

---

Our Vision & Our Mission	Inside Front Cover
Terms & Conditions	1
Chairs & Delivery Units	2-21
Portable Dental Systems	22-25
Stools & X-Ray Chairs	26-28
Operatory Lights	29-31
Mobile Cabinets	32
Imaging Products & Accessories	33-42
Dental Handpiece & Parts	43-55
Handpiece Cleaning & Lubrication Systems	56
Curing & Bleaching	57-66
Scaling Products & Accessories	67-73
Ultrasonic Bath	74-77
Digital Amalgamator	78
Micro Motor & Handpiece	79
Disposable Micro Applicators	80
Disposable Air / Water Syringes	81
Disposable Prophy Angles	82
Disposable Evacuator tips	83
Lab Products	84
Disposable Prophy Cups & Brushes	85
X-Ray Film Holders & Utility Tray	86
Film Mounts	87-90
Autoclavable Air / Water Syringe Tips	91
Deluxe Autoclaveable Valves	92
Parts & Components	93-97
Order Form	Inside Back Cover

Customer Care (8:00 a.m. – 5 p.m. PST)  
 Customer Service Fax Orders  
 Technical Support  
 Sales Support  
 International Sales  
 Latin america sales  
 Shipping  
 Accounting  
 Customer Service  
 Ordering

1-626-810-4337  
 1-626-810-4245  
 service@tpcdental.com  
 sbeckley@tpcdental.com  
 dwang@tpcdental.com  
 alfonso@tpcdental.com  
 holly@tpcdental.com  
 vwang@tpcdental.com  
 customerservice@tpcdental.com  
 customerservice@tpcdental.com



**Ordering Information:**

When placing orders, please include the following information. All orders will be processed upon receipt of a faxed, mailed, or e-mailed hardcopy of the purchase order.

- Model and/or Part Number
- Requested Ship Date
- Description / Voltage
- Purchase Order Number
- Quantity
- Shipping Instructions
- Cancellations must be confirmed in writing
- All credit

cards are accepted unless otherwise noted

**Returned Goods:**

All returns require prior authorization. Returns must be authorized by TPC within 7 days of date received by the customer.

- Contact Customer Service for Return Authorization Number
- Returned products are subject to a 25% restocking charge
- All returned goods must have Return Authorization Number
- All returned goods must be shipped prepaid
- All authorized returns must be received by TPC in original packaging, accessories, documentation and in original condition for credit considerations
- All outbound repair / warranty freight charges are the responsibly of the customer.
- No returns accepted after 14 days.

**Special Orders:**

- Special order items and custom made products are not returnable for credit

**Minimum Orders:**

- Orders less than \$50.00 will incur an additional \$5.00 handling charge.
- All drop ship orders will incur an additional \$5.00 fee.

**Terms of Sale:**

- Claims: All claims for merchandise received that are not in accordance with the original purchase order must be made within five (5) working days of the receipt of the merchandise. All merchandise is quality inspected and packaged in perfect condition. The common carrier assumes full responsibility for the safe delivery of all merchandise after it is removed from the F.O.B. shipping point. All claims for shortages, loss or damage must be documented and filed promptly with the freight carrier. Concealed damage must be reported to the freight carrier immediately upon discovery, with a request for inspection. If a request is made more than 15 days after the receipt of the merchandise, reasonable evidence must be submitted indicating that damage could not have occurred after delivery.
- All pricing in catalog is subject to change. Verify all pricing prior to placing order.

**Warranty Information (All stated warranties are intended for USA market ONLY):**

All of our products sold are guaranteed to be free from defects in workmanship and materials for one year from date of purchase, unless otherwise stated. TPC will repair or replace any defective part at no charge. TPC will not be responsible for labor charges or shipping charges to / from the TPC facility. This guarantee does not cover normal wear or stains on surface finish. The guarantee does not cover damage resulting from improper installation, misuse or accidents incurred in shipping and handling. All claims against the freight carrier must be initiated at the time the damaged items are received. The claim is the responsibility of the customer. We are improving our products on a continuous basis. We reserve the right to make modifications without the need for prior notification and are not obliged

**Products:**

Patient Chairs  
 Operatory Lights (halogen)  
 Curing & Bleaching Systems  
 Imaging Products  
 Scaling Products

**Warranty Period:**

5 year limited  
 1 year  
 1 year  
 1 year  
 1 year

**Products:**

Delivery Units  
 Seating  
 Mobile Cabinets  
 Air-Driven Handpieces  
 Amalgamator

**Warranty Period:**

5 year Limited  
 1 year  
 1 year  
 1 year  
 1 year

**Extended Manufacturer Warranty (selective models):**

H6000, H6005, H6025, H7005 Lubrication System 2 year  
 LED Curing Lights (All Models) 2 year  
 AdvanceCAM Intraoral Camera System(s) 2 year  
 Radiant Operatory Lights 2 year

**Limited Manufacturer Warranty (selective models):**

6 month Manufacturer Warranty (selective models):  
 Fiber optic systems, S333, M333, QS222, QM222, ELCA760, ELS736.

# Mirage

## Chair Mounted Operatory System



MP2015-LED



TP-2005 Touch Pad



TPE-2011 Touch Pad



MP2000-LED

Packing Dimensions (L x W x H)	Weight
Chair: 54 x 34 x 31	310 lbs.
Cushion: 51 x 24 x 10	27 lbs.
Unit: 51 x 21 x 18	53 lbs.
Unit: 19 x 21 x 23	36 lbs.
Dental Light: 38 x 17 x 15	28 lbs.
Cuspidor 20 x 13 x 14	18 lbs.

MP2000-LED shown  
W/ Cuspidor  
**Optional:**MO17 LCD  
WIC840 Bracket

# Mirage

## Chair Mounted Operatory System

Description		Model	Suggested Retail Price
Mirage Operatory Package with Cuspidor		MP2000-LED	\$10,970
Mirage Operatory Package with Assistant's Instrumentation		MP2015-LED	\$10,320
Packages include the following:		(with cuspidor)	(without cuspidor)
4000	Hydraulic patient chair with wide back and full lumbar support, rotating armrests left or right, double articulating headrest with sliding height adjustment, 30 degree swivel from left and right of center, 3 programmable positions with automatic return and foot control	✓	✓
	Asepsis 3 Handpiece automatic control with coolant controls, flex arm with air brake, diaphragm block design, wet/dry variable speed foot control, deluxe utility center with air /water filters and regulators, master shut off valves. Includes 3 way syringe and light post with cutout for internal wires and monitor bracket	✓	✓
	L600-LED Lucent LED post mounted light with adjustable intensity, 3,000-35,000 Lux	✓	✓
2000	Porcelain cuspidor with timed bowl rinse and cup filler, telescoping 4 position assistant's package, Hve and saliva ejector, water / air quick disconnects, solids collector and clean water system	✓	
2015	Asepsis telescoping 4 position assistant's package, Hve and saliva ejector, water / air quick disconnects, solids collector and		✓
<b>Options:</b>			<b>Retail</b>
TPC3WAY-PRT	Additional autoclavable 3 way syringe with tubing		\$67.00
P2330+TB	Deluxe autoclavable Hve valve with tubing		\$55.00
WIC800	Standard flat screen monitor bracket		\$118.00
WIC825	Deluxe flat screen monitor bracket with 16" extension		\$360.00
WIC840	Mirage flat screen monitor bracket with 16" extension		\$190.00
MO17	17" LCD multi media flat screen monitor		\$500.00
A800N-1	Advance 800 piezo scaler – built in		\$490.00
H7000	Illumination System – ISO B (5 hole) – tubing, control box, bulb, power supply		\$278.00
H7040	Illumination handpiece tubing – 5 hole		\$108.00
H7070	Fiber optic bulb cartridge		\$50.00
H7660	Illumination System- ISO C (6 pin) – tubing, control box, power supply		\$238.00
H7045	Illumination handpiece tubing- 6 pin		\$108.00
ALED55BN-A	LED 5W curing light – built in to dental unit		\$390.00
TP-2001	Touch pad control – unit head or dental chair mounted 3 preset, auto return, last position		\$358.00
53016-L	Disposable Solids Collector Trap, 2 1/8' (pack of 100)		\$45.00
2000-C	Mirage Cuspidor		\$650.00
TPE-2003	Touch pad Control - Chair & Electric Motor System touch pad		\$460.00
EMB-901	Built in Electric Motor System		\$1,790.00
XV100	Super thin X-ray film viewer		\$136.00
XV150-R	X-ray film viewer bracket (curved) for TPC Mirage unit only		\$80.00

# Mirage

## Swing Mount Operatory System

Model #3550



Model #3500

MSP3500



TP-2005



TPE-2011

**Optional:** Unit mounted light post LP100 & L600-LED Light Post Mounted LED Light



#L600 LED



**Optional:** LP100 swing mount light post with optional L600-LED Operatory Light



**Optional:** Model #L690-LED Ceiling mounted LED operatory light

Packing Dimensions (L x W x H)	Weight
Chair: 54 x 34 x 31	320 lbs.
Cushion: 51 x 24 x 10	27 lbs.
3500: 44 x 36 x 27	103 lbs.
3550: 21 x 20 x 16	19 lbs.
LP100: 38 x 7 x 30	27 lbs.

# Mirage

## Swing Mount Operatory System

Description	Model	Suggested Retail Price
Mirage Swing Mount Operatory System (without light)	MSP3500	\$10,370

Packages include the following:

4000	Hydraulic patient chair with wide back and full lumbar support, rotating armrests left or right, double articulating headrest with sliding height adjustment, 30 degree swivel from left and right of center, 4 programmable positions with automatic return and foot control	✓
3500	Rotating asepsis 3 Handpiece automatic control with coolant controls, flex arm with air brake, diaphragm block design, wet/dry variable speed foot control, deluxe utility center with air /water filters and regulators, master shut off valves. Includes 3 way syringe and clean water system	✓
3550	Rear radius asepsis assistant's arm system, Hve and saliva ejector, water quick disconnect and solids collector	✓

### Options:

### Retail

3500	Mirage swing mount unit with chair bracket (for TPC chair only)	\$3,600.00
3550	Mirage rear swing mount suction package (for TPC chair only)	\$980.00
LP-100	Mirage swing mount light post (ordered w/unit)	\$700.00
LP-105	Mirage swing mount monitor post with monitor mounting bracket (ordered w/unit)	\$870.00
L600-LED	Lucent LED Operatory Light	\$1,280.00
L690-LED	Lucent LED Ceiling Mounted Operatory Light	\$1,840.00
L700	Advance Operatory Light	\$920.00
TPC3WAY-PR T	Additional autoclavable 3 way syringe with tubing	\$67.00
P2330+TB	Deluxe autoclavable Hve valve with tubing	\$55.00
WIC800	Standard flat screen monitor bracket	\$118.00
WIC825	Deluxe flat screen monitor bracket with 16" extension	\$360.00
WIC840	Mirage flat screen monitor bracket with 16" extension	\$190.00
MO17	17" LCD multi media flat screen monitor	\$500.00
A800N-1	Advance 800 piezo scaler – built in	\$490.00
H7000	Illumination System – ISO B (5 hole) – tubing, control box, bulb, power supply	\$278.00
H7040	Illumination handpiece tubing – 5 hole	\$108.00
H7070	Fiber optic bulb cartridge	\$50.00
H7660	Illumination System – ISO C (6 pin) – tubing, control box, power supply	\$238.00
H7045	Illumination handpiece tubing – 6 pin	\$108.00
ALED55BN-A	LED 5W curing light – built in to dental unit	\$390.00
TP-2001	Touch pad control – unit head or dental chair mounted 3 preset, auto return, last position	\$358.00
XV100	Super thin X-ray film viewer	\$136.00
XV150-R	X-ray film viewer bracket (curved) for TPC Mirage Unit only	\$80.00
TPCRDSBRKT	TPC Radius Bracket	\$320.00
53016-L	Disposable Solids Collector Trap 2 1/8" (pack of 100)	\$45.00
TPE-2003	Touch pad Control - Chair & Electric Motor System Touch pad	\$460.00
EMB-901	Built in Electric Motor System	\$1,790.00

# Mirage

## Patient Chair



Model #4000

### Foot Control

Hands-free positioning of the patient. 2-programmable positions plus an entry/exit position and last position.



Cast aluminum base for high durability



Armrests swing-out for patient entry and exit from the chair



Re-enforced seat upholstery provides extra comfort and high durability



Articulating dual axis headrest rotation allows for optimum positioning of the oral cavity without the need to reposition the chair



Locking lever allows user to lock chair into desired position



Seat rotates 30° to left and right of center to accommodate different working styles and to maximize access to intraoral x-ray system



Safety shut-off plate disables seat down/backrest recline functions to prevent injury to the operator or damage to items beneath the plate.

### Specifications:

Lifting/lowering mechanism:	Hydraulic, cantilever type
Initial height/stroke:	15.5" / 15"
Backrest reclining angle:	0° (Horizontal) – 70°
Seat tilting:	10° – 20°, synchronized with backrest
Preset position:	Microcomputer control. Three preset position, autoreturn, last position
Chair rotation angle:	30° left / 30° right of centerline
Headrest:	Dual axis type
Safety shut-off plate:	Under the main link
Emergency stop:	Any switch can cancel chair movement
Warranty	5 Year Limited

### Standard Features:

- Synchronous backrest
- Articulating dual axis headrest
- Cast aluminum base
- Swing-away armrests
- Programmable foot control
- Short pump cover



# Mirage

## Patient Chair

### Description

Mirage Hydraulic Patient Chair

### Model

#4000

### Suggested Retail Price

\$5,790

Product includes the following:

- Two programmable positions
- One preset exit position
- Electronic foot control with auto return function
- Built-in fuse / surge protection
- Toe guard protection to prevent scuffing
- All-metal construction
- Safety shut-off base plate
- Double articulating headrest, adjustable for height and wheelchair positioning
- Locking swivel, 60 degree
- Pivoting armrests for easy entry to and exit from chair
- Seamless Upholstery
- Wide chair back
- Coordinated leg rest tilt
- Input voltage 110V or 220V

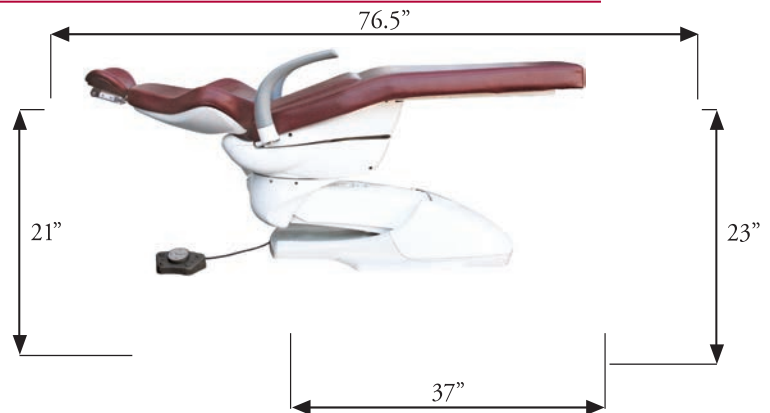

**Standard: PC-1000-DU**  
Wide backrest



**Optional: PC-2000-BC** Narrow backrest with slings.



**Optional: TP-2005** Touch pad control installed on dental chair

Packing Dimensions (L x W x H)	Weight
Chair: 54 x 34 x 31	300 lbs.
Cushion: 51 x 24 x 10	27 lbs.
Chair Bracket 22 x 9 x 6	11 lbs.

### Options:

### Retail

TP-2001	Touch pad control – unit head or dental chair mounted, 3 preset, auto return, last position	\$ 358.00
TPCBRKT	TPC post mount chair bracket	\$ 270.00
PC-1000-DU	Replacement Dental Chair Upholstery Duration Vinyl -Wide Back	\$600.00
PC-1000-Vinyl-UC	Upcharge Non-Standard Dental Chair Upholstery Vinyl -Wide Back	\$450.00
PC-1000-Ultr-UC	Upcharge Ultra leather Dental Chair Upholstery leather -Wide Back	\$700.00
PC-1000-PR-UC	Upcharge Nauga Soft Dental Chair Upholstery Vinly -Wide Back ( PR50, 49, 47, 40, 37 )	\$200.00
PC-2000-DU	Replacement Dental Chair Upholstery Duration Vinyl -Narrow Back	\$740.00
PC-2000-Vinyl-UC	Upcharge Non-Standard Dental Chair Upholstery Vinly -Narrow Back	\$550.00
PC-2000-ultr-UC	Upcharge Ultra Leather Dental Chair Upholstery leather -Narrow Back	\$800.00
PC-2000-PR-UC	Upcharge Nauga Soft Dental Chair Upholstery Vinly -Narrow Back ( PR50, 49, 47, 40, 37 )	\$300.00

\* Specify color and product code when ordering \*

# Mirage

## Orthodontic Hydraulic Patient Chair



### Foot Control

Hands-free positioning of the patient. 2-programmable positions plus an entry/exit position and last position.



Cast aluminum base for high durability



Articulating dual axis headrest rotation allows for optimum positioning of the oral cavity without the need to reposition the chair



Optional armrests swing-out for patient entry and exit from the chair



Locking lever allows user to lock chair into desired position



Seat rotates 30° to left and right of center to accommodate different working styles and to maximize access to intraoral x-ray system



Safety shut-off plate disables seat down/backrest recline functions to prevent injury to the operator or damage to items beneath the plate.

### Specifications:

Lifting/lowering mechanism:	Hydraulic, cantilever type
Initial height/stroke:	15.5" / 15"
Backrest reclining angle:	0° (Horizontal) – 70°
Seat tilting:	10° – 20°, synchronized with backrest
Preset position:	Microcomputer control. Three preset position, autoreturn, last position
Chair rotation angle:	30° left / 30° right of centerline
Headrest:	Dual axis type
Safety shut-off plate:	Under the main link
Emergency stop:	Any switch can cancel chair movement
Warranty	5 Year Limited

### Standard Features:

- Synchronous backrest
- Articulating dual axis headrest
- Cast aluminum base
- Programmable foot control
- Short pump cover

# Mirage

## Orthodontic Hydraulic Patient Chair

### Description

### Model

### Suggested Retail Price

Mirage Orthodontic Hydraulic Patient Chair

#3000

\$5,590

Packages include the following:

- Two programmable positions
- One preset exit position
- Electronic foot control with auto return function
- Built-in fuse / surge protection
- Toe guard protection to prevent scuffing
- All-metal construction
- Safety shut-off base plate
- Double articulating headrest, adjustable for height and wheelchair positioning
- Locking swivel, 60 degree
- Seamless Upholstery
- Coordinated leg rest tilt
- Input voltage 110V or 220V



Optional: TP-2005 Touchpad control installed on dental chair

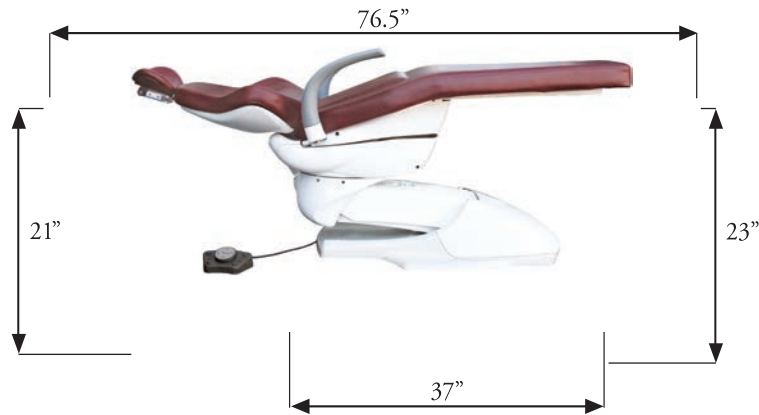

### Options:

### Retail

TP-2001	Touch pad control – unit head or dental chair mounted, 3 preset, auto return, last position	\$ 358.00
TPCBRKT	TPC Post mount chair bracket	\$ 270.00
PC-1000-DU	Replacement Dental Chair Upholstery-Wide Back Duration Vinyl- Specify Color and Product Code	\$600.00
PC-1000-Vinyl-UC	Upcharge Non-Standard Dental Chair Upholstery-Wide Back Vinyl- Specify Color and Product Code	\$450.00
PC-1000-ULTR-UC	Upcharge Ultra leather Dental Chair Upholstery-Wide Back Ultra leather- Specify Color and Product Code	\$700.00
PC-1000-PR-UC	Upcharge Nauga Soft Dental Chair Upholstery-Wide Back Nauga Soft- Specify Color and Product Code ( PR50, 49, 47, 40, 37 )	\$200.00
M4000-09	Magnetic Pillow Headrest	\$390.00

Packing Dimensions (L x W x H)	Weight
Chair: 54 x 34 x 31	300 lbs.
Cushion: 51 x 24 x 10	27 lbs.

# Mirage

## Orthodontic Package

### Standard Features:

- Synchronous backrest
- Articulating dual axis headrest
- Cast aluminum base
- Programmable foot control
- Short pump cover
- Hydraulic pump for quiet operation

### Standard Features:

- Color temperature: 4500° K
- Halogen lamp 12 Volts, 55 Watts
- Bulb type: H3
- Light intensity (Lux):  
High 24,000;  
Low 12,000
- Focal length: 27" (70 cm)
- Illumination area: 3" x 7"

### Standard Control Features:

- 3 HP Automatic selection
- 3-way Syringe
- Vacuum Package with Saliva Ejector and HVE
- Self contained water bottle system
- Variable speed disc-type foot control
- Water coolant on/off switch with flow control
- 1 Year warranty



Optional:  
OMC-2200  
LCD Bracket

MOP3000

Optional: Magnetic  
headrest

Counter top  
dimensions

Rear cabinet  
door view

Pull out writing  
surface

Packing Dimensions (L x W x H)	Weight
Chair: 54 x 34 x 31	300 lbs.
Cushion: 51 x 24 x 10	27 lbs.
Light 26 x 14 x 8	21 lbs.
Cabinet 28 x 26 x 37	155 lbs.

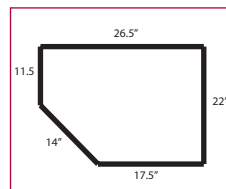
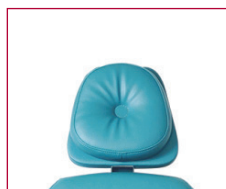

# Mirage

## Orthodontic Package

Description	Model	Suggested Retail Price
Mirage Orthodontic Package	MOP3000	\$9,050

Packages include the following:

3000 Hydraulic patient chair with wide back and full lumbar support, double articulating headrest with sliding height adjustment, 30 degree swivel from left and right of center, 4 programmable positions with automatic return and foot control ✓

2375 This orthodontic mobile delivery cabinet offers a pullout writing surface, two instrument drawers, one medium and two large storage drawers for materials and supplies that fully extend and quickly remove for easy cleaning. In addition, these cabinets provide a large open space for accessories with convenient access from the front. Oversized locking dual-caster wheel ✓

L700 Advance post mounted light with dual intensity, 4200-4500 Kelvin, dual axis light head rotation ✓

TPCBRKT The chair bracket is included at no charge (value: \$270) when purchasing the Mirage Orthodontic Package ✓

### Options:

		Retail
WIC840	Mirage flat screen monitor bracket with 16" extension	\$190.00
MO17	17" LCD multi media flat screen monitor	\$500.00
H7000	Illumination System – ISO B (5 hole) – tubing, control box, bulb, power supply	\$278.00
H7660	Illumination System – ISO C (6 pin) – tubing, control box, power supply	\$238.00
ALED55BN-A	LED 5W curing light – built in to dental unit	\$390.00
TP-2001	Touch pad control – unit head or dental chair mounted 3 preset, auto return, last position	\$358.00
OMC2200	LCD monitor bracket	\$300.00
53016-L-100	Disposable Solids Collector Trap 2 1/8" (Pack of 100)	\$45.00
OMC-ST81	Optional Stone Surface on OMC 2375, Color Artic	\$350.00
OMC-ST82	Optional Stone Surface on OMC 2375, Color White	\$350.00
OMC-ST85	Optional Stone Surface on OMC 2375, Color Cream	\$350.00
OMC-ST86	Optional Stone Surface on OMC 2375, Color Bamboo	\$350.00
M4000-09	Optional Magnetic Headrest	\$390.00

Optional: Stone Counter top  
OMC-ST81

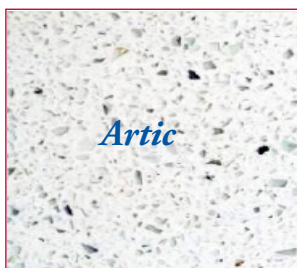

Optional: Stone Counter top  
OMC-ST82



Optional: Stone Counter top  
OMC-ST85



Optional: Stone Counter top  
OMC-ST86



# Laguna

## Electromechanical Patient Chair



**Foot Control**  
Hands-free positioning of the patient. 2-programmable positions plus an entry/exit position.



Reinforced seat upholstery provides extra comfort and durability



Articulating dual axis headrest rotation allows for optimum positioning of the oral cavity without the need to reposition the chair



Optional armrests pivot up and down for patient entry and exit from the chair



Solid steel base

### Specifications:

Lifting/lowering mechanism:	Electromechanical, cantilever type
Initial height/stroke:	15.5" / 15"
Backrest reclining angle:	0° (Horizontal) – 70°
Seat tilting:	10° – 20°, synchronized with backrest
Preset position:	Microcomputer control. Three preset position, auto return, last position
Chair rotation angle:	Fixed
Headrest:	Dual axis type
Safety shut-off plate:	Under the main backrest link
Emergency stop:	Any switch can cancel chair movement
Warranty	5 Year Limited

### Standard Features:

- Independent backrest
- Articulating dual axis headrest
- Solid Steel base
- Programmable foot control
- Short pump cover

# Laguna

## Electromechanical Patient Chair

Description	Model	Suggested Retail Price
Laguna Electromechanical Patient Chair	#L2000	\$3,590

Packages include the following:

- Two programmable positions
- One preset exit position
- Electronic foot control with auto return function
- Built-in fuse / surge protection
- Toe guard protection to prevent scuffing
- All-metal construction
- Double articulating headrest, adjustable for height and wheelchair positioning
- Seamless Upholstery
- Input voltage 110V or 220V



**Optional:** TP-2007 Touch pad control installed on dental chair

Packing Dimensions (L x W x H)	Weight
Chair: 54 x 34 x 32	300 lbs.
Cushion: 51 x 9 x 23	27 lbs.



### Options:

		Retail
TP-2001	Touch pad control – chair mounted, 3 preset, auto return, last position	\$ 358.00
PC-5000-DU	Upcharge Dental Chair Upholstery-Wide Back Duration Vinyl- Specify Color and Product Code	\$600.00
PC-5000-Vinyl-UC	Upcharge Non-Standard Dental Chair Upholstery-Wide Back Vinyl- Specify Color and Product Code	\$450.00
PC-5000-ULTR-UC	Upcharge Ultra leather Dental Chair Upholstery-Wide Back Ultra leather- Specify Color and Product Code	\$700.00
PC-5000-PR-UC	Upcharge Nauga Soft Dental Chair Upholstery-Wide Back Nauga Soft- Specify Color and Product Code	\$450.00
LAGBRKT	Laguna Post mount chair bracket	\$ 270.00

# Laguna

## Chair Mounted Operatory System

LP-2100-600LED



Packing Dimensions (L x W x H)	Weight
Chair: 54 x 34 x 31	310 lbs.
Cushion: 51 x 24 x 10	27 lbs.
Unit: 51 x 21 x 18	53 lbs.
Unit: 19 x 21 x 23	36 lbs.
Dental Light: 38 x 17 x 15	28 lbs.
Cuspidor 20 x 13 x 14	18 lbs.



# Laguna

## Chair Mounted Operatory System

Description	Model	Suggested Retail Price
Laguna Operatory Package with Cuspidor	LP2100-600LED	\$8,770
Laguna Operatory Package with Assistant's Instrumentation		\$8,120
Packages include the following:	(with cuspidor)	(without cuspidor)
L2000 Electromechanical patient chair with wide back and full lumbar support, rotating armrests left or right, double articulating headrest with sliding height adjustment, 30 degree swivel from left and right of center, 3 programmable positions with automatic return and foot control	✓	✓
Asepsis 3 Handpiece automatic control with coolant controls, flex arm with air brake, diaphragm block design, wet/dry variable speed foot control, deluxe utility center with air /water filters and regulators, master shut off valves. Includes 3 way syringe and light post with cutout for internal wires and monitor bracket	✓	✓
L600-LED Lucent LED post mounted light with adjustable intensity, 3,000-35,000 Lux	✓	✓
2000 Porcelain cuspidor with timed bowl rinse and cup filler, telescoping 4 position assistant's package, Hve and saliva ejector, water / air quick disconnects, solids collector and clean water system	✓	
2015 Asepsis telescoping 4 position assistant's package, Hve and saliva ejector, water / air quick disconnects, solids collector and		✓
<b>Options:</b>		<b>Retail</b>
TPC3WAY-PRT Additional autoclavable 3 way syringe with tubing		\$67.00
P2330+TB Deluxe autoclavable Hve valve with tubing		\$55.00
WIC800 Standard flat screen monitor bracket		\$118.00
WIC825 Deluxe flat screen monitor bracket with 16" extension		\$360.00
WIC840 Mirage flat screen monitor bracket with 16" extension		\$190.00
MO17 17" LCD multi media flat screen monitor		\$500.00
A800N-1 Advance 800 piezo scaler – built in		\$490.00
H7000 Illumination System – ISO B (5 hole) – tubing, control box, bulb, power supply		\$278.00
H7040 Illumination handpiece tubing – 5 hole		\$108.00
H7070 Fiber optic bulb cartridge		\$50.00
H7660 Illumination System- ISO C (6 pin) – tubing, control box, power supply		\$238.00
H7045 Illumination handpiece tubing- 6 pin		\$108.00
ALED55BN-A LED 5W curing light – built in to dental unit		\$390.00
TP-2001 Touch pad control – unit head or dental chair mounted 3 preset, auto return, last position		\$358.00
53016-L Disposable Solids Collector Trap, 2 1/8' (pack of 100)		\$45.00
2000-C Mirage Cuspidor		\$650.00
TPE-2003 Touch pad Control - Chair & Electric Motor System touch pad		\$460.00
EMB-901 Built in Electric Motor System		\$1,790.00
XV100 Super thin X-ray film viewer		\$136.00
XV150-R X-ray film viewer bracket (curved) for TPC Mirage unit only		\$80.00

# Laguna

## Orthodontic Package

### Standard Features:

- Independent backrest
- Articulating dual axis headrest
- Steel base
- Armrests pivot up and down
- Programmable foot control
- Short pump cover
- Electric motor operated

### Standard Features:

- Color temperature: 4500° K
- Halogen lamp 12 Volts, 55 Watts
- Bulb type: H3
- Light intensity (Lux):  
High 24,000;  
Low 12,000
- Focal length: 27" (70 cm)
- Illumination area: 3" x 7"

### Standard Control Features:

- 3 HP Automatic selection
- 3-way Syringe
- Vacuum Package with Saliva Ejector and HVE
- Self contained water bottle system
- wet / dry foot control
- 1 Year warranty



LOP2000

### Standard Cabinet Features:

- Five easy to remove and clean full extension drawers, and one pull-out writing surface.
- High quality hardware throughout
- Oversized caster wheels
- Four stationary handles for easy cart positioning
- A removable counter - top plastic tray
- Standard 12" X 12" Junction Box
- 5' Length of umbilical

Packing Dimensions (L x W x H)	Weight
Chair: 54 x 34 x 32	300 lbs.
Cushion: 52 x 24 x 10	27 lbs.
Light 26 x 14 x 8	21 lbs.
Cabinet 26 x 28 x 37	155 lbs.

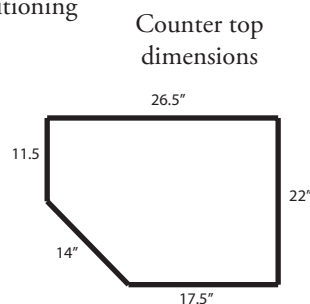

Rear cabinet door view



Pull out writing surface



# Laguna

## Orthodontic Package

Description	Model	Suggested Retail Price
Laguna Orthodontic Package	LOP2000	\$7,170

Packages include the following:

L2000 Electromechanical patient chair with wide back and full lumbar support, double articulating headrest with sliding height adjustment, 3 programmable positions with automatic return and foot control ✓

2375 This orthodontic mobile delivery cabinet offers a pullout writing surface, two instrument drawers, one medium and two large storage drawers for materials and supplies that fully extend and quickly remove for easy cleaning. In addition, these cabinets provide a large open space for accessories with convenient access from the front. Oversized locking dual-casters. ✓

L700 Advance post mounted light with dual intensity, 4200-4500 Kelvin, dual axis light head rotation ✓

LAGBRKT The chair bracket is included at no charge (value: \$270) when purchasing the Laguna Orthodontic Package ✓

### Options:

		Retail
WIC840	Mirage flat screen monitor bracket with 16" extension	\$190.00
M017	17" LCD multi media flat screen monitor	\$500.00
H7000	Illumination System – ISO B (5 hole) – tubing, control box, bulb, power supply	\$278.00
H7660	Illumination System – ISO C (6 pin) – tubing, control box, power supply	\$238.00
ALED55BN-1	LED 5W curing light – built in to dental unit	\$390.00
TP-2001	Touch pad control – chair mounted, 3 preset, auto return	\$358.00
OMC2200	LCD monitor bracket	\$300.00
53016-L-100	Disposable Solids Collector Trap 2 1/8" (pack of 100)	\$45.00
OMC-ST81	Optional Stone Surface on OMC 2375, Color Artic	\$350.00
OMC-ST82	Optional Stone Surface on OMC 2375, Color White	\$350.00
OMC-ST85	Optional Stone Surface on OMC 2375, Color Cream	\$350.00
OMC-ST86	Optional Stone Surface on OMC 2375, Color Bamboo	\$350.00
LAGBRKT	Laguna Post mount chair bracket	\$270.00

Optional: Stone Counter top  
OMC-ST81

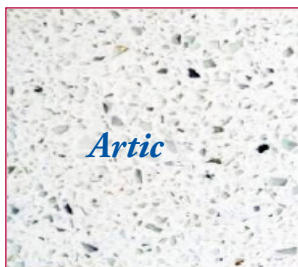

Optional: Stone Counter top  
OMC-ST82



Optional: Stone Counter top  
OMC-ST85

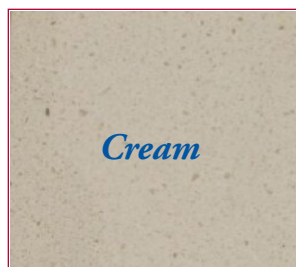

Optional: Stone Counter top  
OMC-ST86



# Mirage

## Chair Mounted Delivery System



### Standard Features

- Asepsis automatic control for three handpieces
- Individual handpiece pressure adjustments
- Non-retracting water coolant with on/off
- Individual water coolant flow controls
- Air coolant flow control
- Handpiece tubing flush system
- Ultra soft handpiece tubing
- 4-hole straight gray asepsis tubing with Midwest connector
- Stainless steel tray with non-skid pad
- Disc foot control wet/dry toggle with 7' of smooth tubing
- Equipment utility center with asepsis housing
- Vacuum canister with solids collector screen
- Water outlet quick disconnect
- Air outlet quick disconnect for prophylaxis jet
- Self contained water system with city/bottle selector switch
- Straight light post for unit mount dental light
- Pre-wiring for fiber optic light source
- Air-actuated counterbalanced arm lock
- 3 way syringe on unit head

### Gravity Drain Cuspidor

- Contoured bowl is made of fine porcelain for easy cleaning and infection control.
- The cuspidor operates with adjustable timed bowl rinse and cup filler
- Swing away cuspidor bowl with safety breakaway feature
- Electric solenoid controlled

### Assistant's Instrumentation on Telescoping Arm

- 1 autoclavable HVE with asepsis tubing
- 1 autoclavable saliva ejector with asepsis tubing

### Options

- Built In Electric Handpiece
- Super thin X-ray viewer to mount on unit control head
- Built-in Led curing light
- Built-in scaler
- Illumination light source
- Post-mounted utility tray
- 17" LCD Monitor
- LCD monitor bracket



Model 2000



TP-2005



TPE-2011



**Control Head:** Easy to read pressure gauge. Easy access controls for simple adjustments. Ultra soft handpiece tubing minimizing hand and wrist stress.



**Cuspidor Bowl:** The deep contoured bowl is made of fine porcelain for easy cleaning and infection control.



**Optional:** Multi media flat screen monitor for chair side intraoral imaging, patient education and DVD viewing.



Built in self contained water bottle system including city/bottle selector switch.



**Optional:** Super thin xray viewer mounted to unit head.



Built in air and water quick disconnect for ultrasonic scaling and prophylaxis jet

# Mirage

## Chair Mounted Delivery System

Model #2015



Optional: TP-2005  
Touchpad control



Optional: TPE-2011  
Touchpad control

Packing Dimensions (L x W x H)	Weight
Unit: 51 x 21 x 17	55 lbs.
Unit: 19 x 21 x 23	36 lbs.
Cuspidor: 13 x 14 x 21	18 lbs.

### Description

Mirage Chair Mounted Delivery System with Cuspidor  
Mirage Chair Mounted Delivery System

#### Package includes the following:

Asepsis 3 handpiece automatic control with coolant controls, flex arm with air brake, diaphragm block design, wet/dry variable speed foot control, deluxe utility center with air /water filters and regulators, master shut off valves. Includes 3 way syringe and light post with cutout for internal wires and monitor bracket, 5' umbilical

Porcelain cuspidor with timed bowl rinse and cup filler, telescoping 4 position assistant's package, Hve and saliva ejector, water / air quick disconnects, solids collector and clean water system

Asepsis telescoping 4 position assistant's package, Hve and saliva ejector, water/air quick disconnect, solids collector and clean water system

Light Post

### Model

### Suggested Retail Price

	2000	2015
	(with cuspidor)	(without cuspidor)
Mirage Chair Mounted Delivery System with Cuspidor		<b>\$3,900</b>
Mirage Chair Mounted Delivery System		<b>\$3,250</b>
Asepsis 3 handpiece automatic control with coolant controls, flex arm with air brake, diaphragm block design, wet/dry variable speed foot control, deluxe utility center with air /water filters and regulators, master shut off valves. Includes 3 way syringe and light post with cutout for internal wires and monitor bracket, 5' umbilical	✓	✓
Porcelain cuspidor with timed bowl rinse and cup filler, telescoping 4 position assistant's package, Hve and saliva ejector, water / air quick disconnects, solids collector and clean water system	✓	
Asepsis telescoping 4 position assistant's package, Hve and saliva ejector, water/air quick disconnect, solids collector and clean water system		✓
Light Post	✓	✓

### Options:

	Retail
TPC3WAY-PRT Additional autoclavable 3 way syringe with tubing	\$67.00
P2330+TB Deluxe autoclavable Hve valve with tubing	\$55.00
WIC800 Standard flat screen monitor bracket	\$118.00
WIC825 Deluxe flat screen monitor bracket with 16" extension	\$360.00
WIC840 Mirage flat screen monitor bracket with 16" extension	\$190.00
M017 17" LCD multi media flat screen monitor	\$500.00
A800N-1 Advance 800 piezo scaler – built in	\$490.00
H7000 Illumination System – ISO B (5 hole) – tubing, control box, bulb, power supply	\$278.00
H7660 Illumination System – ISO C (6 pin) – tubing, control box, power supply	\$238.00
ALED55BN-A LED 5W curing light – built in	\$390.00
L600-LED Lucent LED Operatory Light	\$1,280.00
L625-LED Lucent LED Operatory Light with motion sensor	\$1,430.00
BELBRKT Belmont chair mount bracket (Bel 20/Bel 50)	\$165.00
TPCBRKT TPC chair mount bracket	\$270.00
TP-2001 Touch pad control – unit head or dental chair mounted, 3 preset, auto return, last position	\$358.00
TPE-2003 Touch pad Control - Chari & Electric Motor System touch pad	\$460.00
53016 -L-100 Disposable Solids Collector Trap, 2 1/8" (pack of 100)	\$45.00
2000-C Mirage Cuspidor	\$650.00
EMB-901 Built In Electric Motor system	\$1,790.00
XV100 Super Thin X-ray Viewer	\$136.00
XV150-R Xray viewer bracket (round cut-out) – mount to Mirage unit head (Round Arm)	\$80.00

# Mirage

## Mobile Cart



Model #MC-501



Model #MC-500

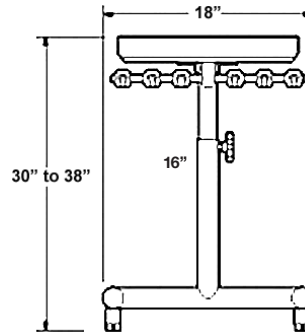

### Description

Mirage Mobile Cart  
Mirage Mobile Cart with Vacuum Package

### Model

MC-500  
MC-501

### Suggested Retail Price

\$2,100  
\$2,300

- Asepsis 3 handpiece automatic selection with bottle system
- 3 way syringe with quick change autoclavable tip
- Master on/off toggle
- Air / Water pressure adjustment for each handpiece
- Pressure gauge
- Non-retracting water / air coolant adjustment and purge
- Asepsis handpiece tubing
- Painted U-frame with height adjustment, 30" to 38"
- Vacuum canister with removable screen, water quick disconnect
- 1 autoclavable Hve and saliva ejector and tubing
- Variable speed foot control
- 5 feet of umbilical

- ✓
- ✓
- ✓
- ✓
- ✓
- ✓
- ✓
- ✓
- ✓
- ✓
- ✓
- ✓

### Options:

- H7660 Illumination system – ISO C (6 pin) – tubing, control box, power supply
- H7000 Illumination system – ISO B (5 hole) – tubing, control box, bulb, power supply
- A800N-1 Advance 800 N piezo scaler – built in
- 53106-L-100 Disposable Solids Collector Trap, 2 1/8" Pk of 100
- MC500-UMB-FT Additional Umbilical Per Foot
- MC501-UMB-FT Additional Umbilical Per Foot

### Retail

- \$238.00
- \$278.00
- \$490.00
- \$45.00
- \$32.00
- \$35.50

Model #MC-501

Model #MC-500

Packing Dimensions: 24" x 24" x 36" / 52 lbs

Packing Dimensions: 24" x 24" x 36" / 50 lbs



# Mirage

## Wall / Cabinet Mounted System



Model #MS-3000

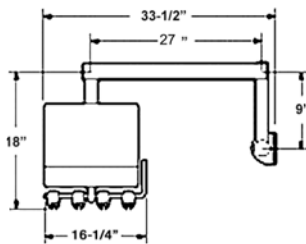

Model #MR-4000

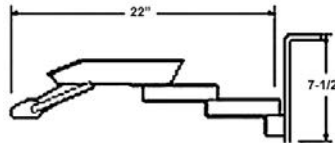

Model #MVP-5000

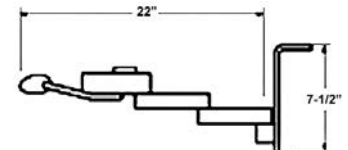

### Suggested Retail Price

Mirage Cabinet Mounted Side Delivery Unit	MS-3000		\$2,590
Mirage Cabinet Mounted Rear Delivery Unit		MR-4000	\$1,650
Mirage Cabinet Mounted Vacuum Package		MVP-5000	\$760

Asepsis 3 handpiece automatic selection with bottle system	✓	✓	
3 way syringe with quick change autoclavable tip	✓	✓	
Master on/off toggle	✓	✓	
Air / Water pressure adjustment for each handpiece	✓	✓	
Pressure gauge	✓	✓	
Non-retracting water / air coolant adjustment and purge	✓	✓	
Asepsis handpiece tubing	✓	✓	(39" reach, 19" vertical)
Asepsis flex arm system, w/ 9" rigid arm, pneumatic brake	✓		
2" diameter wall bracket	✓		(22" reach)
Pivoting arm mounted vacuum canister w/ screen			✓
3 way syringe with quick change autoclavable tip			✓
Water quick disconnect			✓
Vacuum canister with removable screen			✓
4 position holder, 1 autoclavable Hve and saliva ejector & tubing			✓
Variable speed foot control	✓	✓	

### Options:

H7660	Illumination system – ISO C (6 pin) – tubing, control box	\$238.00
H7000	Illumination system – ISO B (5 hole) – tubing, control box, bulb	\$278.00
A800N	Advance 800 piezo scaler – built in	\$490.00
P2330+TB	Deluxe autoclavable Hve valve with tubing	\$55.00
53106-L-100	Disposable Solids Collector Trap, 2 1/8" (Pack of 100)	\$45.00

### Retail

Packing Dimensions: 17" x 21" x 51" / 48 lbs  
MS-3000

Packing Dimensions: 22" x 20" x 15" / 22 lbs  
MR-4000

Packing Dimensions: 13" x 13" x 8" / 10 lbs  
MVP-5000

# Mirage

## Panel & Cabinet Mount Systems



Model #MP-2600  
Mirage Panel Mount  
Rear Delivery System



Model #MP-2601  
Mirage wall / Cabinet Mount  
Rear Assistants package



Model #MR-4500  
Mirage Rear Cabinet Mount  
Delivery System with Assistants Package



### Standard Features

- 2 Handpiece Tubing Positions
- 3 Position HP Holder
- TPC Press ring style syringe
- Individual drive air & water coolant controls
- Foot control
- Control Dimensions 8 1/2" x 1 3/4" x 5"
- Cut-out dimensions 7 1/2" x 11 1/2"
- Syringe has adjustable air & water controls
- Air / Water master control W/ Regulator.

### Standard Features

- 2 HVE Suciton Valves
- 1 SE Suction Valve
- 3 Position Suction Holder
- Vacuum canister with removable screen

### Standard Features

- Asepsis 3 handpiece automatic selection with bottle system
- 3 way syringe with quick change autoclavable tip
- Master on/off toggle
- Air / Water pressure adjustment for each handpiece
- Pressure gauge
- Non-retracting water / air coolant adjustment and purge
- Asepsis handpiece tubing
- Asepsis flex arm system, w/ 9" rigid arm, pneumatic brake
- Self contained bottle system
- Stainless Steel tray
- 3 way syringe with quick change autoclavable tip
- Utility center
- Vacuum canister with removable screen

### Description

### Model

### Suggested Retail Price

Mirage Panel Mount Rear Delivery System (2 HP manual select, 3-Way Syringe, 3 position HP holder, Utility Valves)	MP-2600	\$770.00
Mirage Wall & Cabinet Mount Assistance Package (2 HVE, 1 SE, 3 position holder)	MP-2601	\$270.00
Mirage Rear Cabinet Mounted Delivery System W/ Assistants Package	MR-4500	\$2,250.00

### Options:

### Retail

H7660	Illumination system – ISO C (6 pin) – tubing, control box	\$238.00
H7000	Illumination system – ISO B (5 hole) – tubing, control box, bulb	\$278.00
A800N	Advance 800 piezo scaler – built in	\$490.00
P2330+TB	Deluxe autoclavable Hve valve with tubing	\$55.00
53106-S-100	Disposable Solids Collector Trap, 1 7/8" (Pack of 100)	\$45.00
53106-L-100	Disposable Solids Collector Trap, 2 1/8" (Pack of 100)	\$45.00

Packing Dimensions: 8" x 17" x 15" / 9 lbs  
MP-2600

Packing Dimensions: 8" x 17" x 15" / 5 lbs  
MP-2601

Packing Dimensions: 20" x 20" x 15" / 27 lbs  
MP-4500



# OMC 2375

## Orthodontic Mobile Delivery Cabinet



Optional OMC 2200  
Monitor Bracket



Rear compartment

4" W  
X  
12" D  
X  
20" H



Writing surface with  
optional solid surface

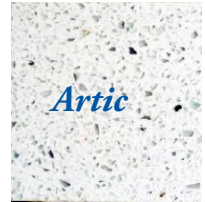

Artic

OMC-ST81



White

OMC-ST82

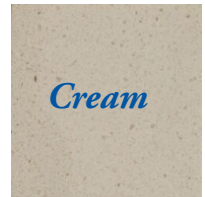

Cream

OMC-ST85



Bamboo

OMC-ST86

Optional hard surface stone top

### Function:

This orthodontic mobile delivery cabinet offers a pullout breadboard, two instrument drawers, one medium and two large storage drawers for materials and supplies that fully extend and quickly remove for easy cleaning. In addition, these cabinets provide a large open space for accessories with convenient access from the front. The oversized dual-caster wheels, makes positioning of the cabinet simple and easy on all floor surfaces, including carpet.

### Standard Cabinet Features:

- Five easy to remove and clean full extension drawers, and one pull-out writing surface.
- High quality hardware throughout
- Oversized caster wheels
- Four stationary handles for easy cart positioning
- A removable counter - top plastic tray
- Standard 12" X 12" Junction Box
- 5' Length of umbilical

### Standard Control Features:

- 3 HP Automatic selection
- 3-way Syringe
- Vacuum Package with Saliva Ejector and HVE
- Self contained water bottle system
- Variable speed disc-type foot control
- Water coolant on/off switch with flow control
- 1 Year warranty

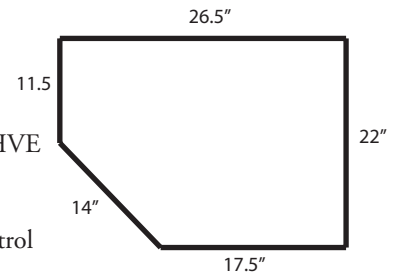

### Description

### Model

### Suggested Retail Price

Orthodontic Mobile Delivery Cabinet

OMC2375

\$2,390

### Options:

### Retail

A800N-1	Advance 800N Piezo Scaler - Built in	\$490.00
ALED55BN-A	LED 55BN 5W LED Curing Light -Built in	\$390.00
2375-UMB-FT	Umbilical Per Foot	\$32.00
OMC2200	LCD Monitor Bracket W/ Post	\$300.00
OMC-ST81	Optional Stone Surface on OMC 2375, Color Artic	\$350.00
OMC-ST82	Optional Stone Surface on OMC 2375, Color White	\$350.00
OMC-ST85	Optional Stone Surface on OMC 2375, Color Cream	\$350.00
OMC-ST86	Optional Stone Surface on OMC 2375, Color Bamboo	\$350.00
53016-L-100	Disposable Solids Collector Trap 2 1/8" (Pack of 100)	\$45.00

Packing Dimensions: 26" x 28" x 37" / 155 lbs

# PC 2700

## Portable Dental Chair Package



Description	Model	Suggested Retail Price
Portable Dental Chair Package (Includes patient Chair, Light, Stool, Tray, Spittoon & heavy duty Carry bags)	PC 2700	\$1,730

Options	Model	Suggested Retail Price
PC 2720	Portable Patient Chair	\$650.00
PC 2740	Portable Dr. Stool	\$390.00
PC 2760	Portable Operatory Light	\$390.00
PC 2780	Stainless Steel tray and spit cup	\$150.00
PC 2790	Portable chair heavy duty carry bag	\$180.00
PC 2795	Stool heavy duty carry bag	\$160.00

### Shipping Dimensions:

Packing Dimensions: 17" x 22" x 30" / 78 lbs

# PC 2630

## Portable Delivery System

- PC2930: Includes
- LED Curing light
  - Piezo Scaler



The **PC2630** is a fully self contained air dental system. Quick and easy to setup and operate. Ready for travel. Tornado HP available upon request. Ask for details.

Description	Model	Suggested Retail Price
-------------	-------	------------------------

Portable Dental System	PC2630	\$1,950
Portable Dental System W/ Scaler & LED Curing Light	PC2930	\$2,800

**Package Includes the following**

• 4 hole or 2 hole instrument tubings (specify)	✓	✓
• 3 way syringe	✓	✓
• Saliva ejector	✓	✓
• Self contained water bottle system	✓	✓
• Self contained oil - less ompressor (580W / 7L)	✓	✓
• Foot control	✓	✓
• Air venturi vacuum system	✓	✓
• Transportation case with pull out handle.	✓	✓
• 1 year warranty	✓	✓
• Built In Scaler		✓
• Built In Curing Light		✓

Options:	Retail
A800N-1 Advance 800 piezo scaler – built in "Factory Installed"	\$540.00
53012-INSTL Female Quick disconnect (factory installed)	\$110.00

**Shipping Dimensions: pc2630**

Packing Dimensions: 16" x 20" x 27" / 56 lbs

**Shipping Dimensions: pc2930**

Packing Dimensions: 16" x 20" x 27" / 60 lbs

# PC 2635

## Portable Delivery System



The **PC2635** is a portable, self contained delivery system suitable for use in-office, nursing homes, hospitals, or wherever any off-site dentistry is required. The PC2635 is a lightweight, portable system that is easily transported. Air and water supply are included on the PC2635 portable dental system. Optional Tornado High and Slow speed handpieces are available.

### Description

### Model

### Suggested Retail Price

Portable Dental System

PC2635

\$1,425

### Package Includes the following

- 4 hole or 2 hole instrument tubings (specify)
- 3 way syringe
- Self contained oil - less compressor (580W / 7L)
- Foot control
- Automatic Handpiece flush System
- Built in carrying handle
- Self contained water bottle system
- 1 year warranty



### Shipping Dimensions:

Packing Dimensions: 23" x 15" x 22" / 66 lbs

# PC 2530

## Mobile Vacuum System



- Moves with Ease
- Efficient
- Simple Maintenance
- Perfect Backup
- Cost Effective
- Compact

### Specifications

Electrical:	7/8 Horsepower 115 VAC, 50/60 Hz 230 VAC, 50/60 Hz 4.0 Amps
Sound:	70 db
Motor:	Variable speed control
Construction:	Impact resistant molded polyethylene
Vacuum:	80" of water (6" of Hg)
Airflow:	75 cfm
Canister:	2 Liter
Dimensions:	14" L x 12" W x 31" H
Shipping:	Freight

The PC 2530 Mobile Vac System is a portable, self contained vacuum system suitable for use by the dentist in a temporary location or when it is not feasible to install a central vacuum system.

Description	Model	Suggested Retail Price
Mobile Vacuum System	PC2530	\$1,480

### Package Includes the following

- HVE and SE Valves ✓
- Drain Line ✓
- 2 SE suction tips ✓
- Power cord ✓
- Solids filter ✓
- 1 year warranty ✓

### Shipping Dimensions:

Packing Dimensions: 18" x 17" x 33" / 71 lbs

# Mirage

## Operatory Stools

Model SS-5105



**Dimensions:**

vertical adjustment range: 0" – 3.5"  
 Seat width: 13" x 14"  
 Seat height ranges: 23" – 31"  
 5-Leg base diameter: 24"  
 Shipping dimensions: 22" x 21" x 15" / 23 lbs.

Model DR-1102



**Dimensions:**

Backrest vertical adjustment range: 0" – 3.25"  
 Seat width: 18"  
 Seat height ranges: 19" – 23"  
 5-Leg base diameter: 24"  
 Shipping dimensions: 24" x 23" x 16" / 34 lbs.

Model DR-5109



**Dimensions:**

Backrest vertical adjustment range: 0" – 3.25"  
 Seat width: 15 3/4"  
 Seat height ranges: 19" – 23"  
 5-Leg base diameter: 24"  
 Shipping dimensions: 23" x 22" x 16" / 38 lbs.

**Description**

Mirage saddle stool  
 Mirage doctor's stool  
 Mirage doctor's stool with armrests

**Model**

SS-5105  
 DR-1102  
 DR-5109

**Suggested Retail Price**

\$490  
 \$460  
 \$600

**Stool Package includes the following:**

Five-leg, ultra stable base, 24" diameter	✓	✓	✓
Gas cylinder lift for seat height adjustment	✓	✓	✓
Adjustable for right or left hand use	✓	✓	✓
Large, firm cushion seat	✓	✓	✓
Adjustable full ring foot rest	✓		
Dual wheel casters	✓	✓	
Adjustable anatomical body support bar	✓	✓	
Height adjustment	23" - 31"	19" - 23"	19" - 23"
16 Upholstery color choices	✓	✓	✓
Seat tilt	✓	✓	
Adjustable armrest			✓
1 year warranty	✓	✓	✓

**Options** \*Specify Color And Product Code\*

DR1102-9	Replacement DR1102 Seat Cushion ONLY Duration Vinyl	\$140.00
DR1102-11	Replacement DR1102 Chair Back Cushion ONLY Duration Vinyl	\$110.00
DR1102-Vinyl-UC	Upcharge Non Standard Vinyl DR1102 Upholstery upcharge	\$130.00
DR-1102-ULTR-UC	Upcharge Ultra leather DR1102 Upholstery upcharge	\$250.00
DR-5109-Vinyl-UC	Upcharge Non Standard Vinyl DR5109 Upholstery upcharge	\$150.00
DR-5109-ULTR-UC	Upcharge Ultra leather DR5109 Upholstery upcharge	\$290.00
SS-5105-Vinyl-UC	Upcharge Non Standard Vinyl SS5105 Upholstery upcharge	\$140.00
SS-5105-ULTR-UC	Upcharge Ultra leather SS5105 Upholstery upcharge	\$270.00

# Mirage

## Assistants Stool

Model AS-1101



**Dimensions:**

Backrest vertical adjustment range: 0" – 3.25"  
 Seat width: 18"  
 Seat height ranges: 19" –23"  
 5-Leg base diameter: 24"  
 Packing dimensions: 24" x 23" x 20" / 45 lbs.

Model HY-1107



**Dimensions:**

Backrest vertical adjustment range: 0" – 3.25"  
 Seat width: 18"  
 Seat height ranges: 19" –23"  
 5-Leg base diameter: 24"  
 Packing dimensions: 22" x 21" x 15" / 30 lbs.

Description	Model	Suggested Retail Price
Mirage assistants stool	AS-1101	\$550
Mirage hygiene stool	HY-1107	\$460

**Stool Package includes the following:**

Five-leg, ultra stable base, 24" diameter	✓	✓
Gas cylinder lift for seat height adjustment	✓	✓
Large, firm cushion seat	✓	✓
Durable tile / carpet Casters	✓	✓
Adjustable full ring foot rest	✓	
Adjustable for right or left handed use	✓	
Adjustable anatomical body support bar	✓	
Seat tilt		✓
Height adjustment	22" - 29"	19" - 23"
1 year warranty	✓	✓

**Options** \*Specify Color And Product Code\*

AS1101-16	Replacement AS1101 Seat Cushion ONLY Duration Vinyl	\$140.00
AS1101-21	Replacement AS1101 Chair Back Cushion ONLY Duration Vinyl	\$110.00
AS1101-18	Replacement AS1101 Abdominal Bar Cushion ONLY Duration Vinyl	\$105.00
AS1101-Vinyl-UC	Upcharge Non Standard Vinyl AS1101 Upholstery Upcharge	\$150.00
AS1101-ULTR-UC	Upcharge Ultra leather AS1101 Upholstery Upcharge	\$290.00

# Mirage

## X-ray Chair



Model XR-6101

### Dimensions:

Seat width: 21"  
 Seat height ranges: 21.5" – 27.5"  
 Base diameter: 24"  
 Packing dimensions: 31" x 20" x 11" / 46 lbs.  
 8" x 8" x 18" / 17 lbs.  
 24" x 24" x 4" / 14 lbs.

Description	Model	Suggested Retail Price
Mirage Xray chair	XR-6101	\$1,100

### X-ray stool Package includes the following:

Adjustable headrest	✓	
Gas cylinder lift for seat height adjustment	✓	
Pneumatic pump on base	✓	
Large, firm cushion seat	✓	
Large diameter base	✓	
Height adjustment	✓	21.5" - 27.5"
16 Upholstery color choices	✓	
Arm rest	✓	
Leg rest	✓	
1 year warranty	✓	

### Options

XR-6101-8-C	Replacement XR6101 Duration Vinyl Seat Cushion ONLY	\$120.00
XR-6101-9-C	Replacement XR6101 Duration Vinyl Chair Back Cushion ONLY	\$140.00
XR-6101-10-C	Replacement XR6101 Duration Vinyl Headrest Cushion ONLY	\$78.00
XR-6101-Vinyl-UC	Upcharge Non Standard Vinyl XR6101 Upholstery Upcharge	\$290.00
XR-6101-ULTR-UC	Upcharge Ultra leather XR6101 Upholstery Upcharge	\$460.00



# Lucent LED

## Operator Light



Model #L600-LED



Model L690-LED  
Ceiling mounted  
Lucent LED  
operator light.

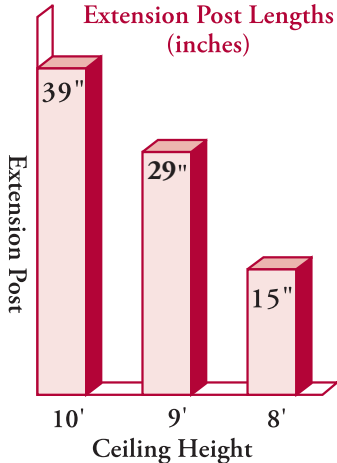

Packing Dimensions (L x W x H)	Weight
L900-08: 15 x 3 x 3	3 lbs.
L900-09: 30 x 3 x 3	5 lbs.
L900-10: 44 x 4 x 4	7 lbs.

#LP48 Light Post must be ordered if dental light is ordered separately

**Specifications:**

Absorbed Power:	Max 8vA
Input voltage:	110V/220V, 60/50 Hz
Output voltage:	24 Volts AC / DC

Light intensity (Lux):	3,000 - 35,000 Lux @ 700mm
Cooling System:	Static Heat sink (no fan)
Illumination area:	100mm x 180mm @ 700mm

Description	Model	Suggested Retail Price
Lucent LED Post Mount Operator Light	L600-LED	\$1,280
Lucent LED Post Mount Operator Light with motion sensor	L625-LED	\$1,430
Lucent LED Ceiling Mounted Light (specify 8', 9' or 10' ceiling)	L690-LED	\$1,840
Lucent LED Ceiling Mounted Light (specify 8', 9' or 10' ceiling) with motion sensor	L695-LED	\$1,990

**Package includes the following:**

Input voltage 110V	✓	✓	✓	✓
2 year warranty	✓	✓	✓	✓

**Options:**

Options	Retail
RLL-H04 Replacement LED light optical bulb group	\$250.00
RLL-H06 Replacement light handle (Left and Right)	\$90.00
RLL-H01 Replacement shield	\$73.00
RLL-H03 Replacement reflector / set of 2	\$96.00
RLL-PS 110 - 240 V Power supply in 24 V out	\$78.00
LP-48 48" light post	\$149.00
L900-08 Ceiling post for 8' ceiling height	\$176.00
L900-09 Ceiling post for 9' ceiling height	\$176.00
L900-010 Ceiling post for 10' ceiling height	\$176.00

Packing Dimensions (L x W x H)	Weight
L600: 38 x 17 x 15	28 lbs.
L690: 38 x 17 x 15	34 lbs.

# Advance

## Operatory Light



#LP48 Light Post must be ordered if dental light (#L800 or #L700) is ordered separately

### Specifications:

Halogen lamp:	12 Volts, 55 Watts	Light intensity (Lux):	High 24,000; Low 12,000
Input voltage:	110V, 60 Hz	Focal length:	27" (70 cm)
Output voltage:	High 12V; Low 10.5V	Illumination area:	3" x 7" at focal length
Color temperature:	4500° K	Shipping Dimensions:	26"L x 14"W x 8" H / 21 lbs.
Bulb type:	H3		

Description	Model	Suggested Retail Price
Advance Operatory Light (white)	L700-1	\$920
Advance Operatory Light (Grey)	L700-1-G	\$920

### Package includes the following:

Input voltage 110V	✓
1 year warranty	✓

### Options:

		Retail
P901	Replacement light bulb	\$15.00
P702	Replacement light handle	\$52.00
P703-N	Replacement shield	\$27.00
P705	Replacement reflector	\$160.00
P56004-700	Transformer	\$120.00
LP-48	48" light post	\$149.00



# Radiant LED

## Operatory Light

Model #R6101-LED



Radiant light handles are removable and sterilizable

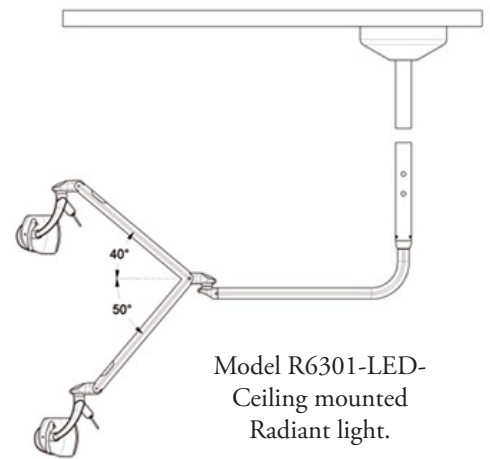
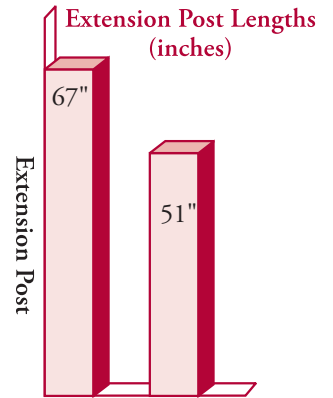

Model R6301-LED-Ceiling mounted Radiant light.

#LP48-RI Light Post must be ordered if dental light is ordered separately

### Specifications:

Absorbed Power:	Max 8vA	Light intensity (Lux):	3,000 - 35,000 Lux @ 700mm
Input voltage:	110V/220V, 60/50 Hz	Cooling System:	Static Heat sink (no fan)
Output voltage:	24 Volts AC / DC	Illumination area:	100mm x 180mm @ 700mm
Bulb type:	LED		

Description	Model	Suggested Retail Price
Radiant LED Operatory Light	R6101-LED	\$1,550
Radiant LED Operatory Light with motion sensor	R6105-LED	\$1,700
Radiant LED Ceiling Mounted Light (specify 9' or 10' ceiling)	R6301-LED	\$2,750
Radiant LED Ceiling Mounted Light motion sensor (specify 9' or 10' ceiling)	R6305-LED	\$2,900

### Package includes the following:

Input voltage 110V - 240 Vac	✓	✓	✓
2 year warranty	✓	✓	✓

### Options:

Options:	Retail
RLL-H04 Replacement LED light optical bulb group	\$250.00
RLL-H06 Replacement light handle (Left and Right)	\$90.00
RLL-H01 Replacement shield	\$73.00
RLL-H03 Replacement reflector / set of 2	\$96.00
RLL-PS 110 - 240 V Power supply in 24 V out	\$78.00
LP-48-RI 48" light post	\$149.00
R-08500 Wall Mount Bracket	\$550.00

### Nylon Bushing

#LP-RI-S Included with models R6101-LED, R6105-LED

- OD 1 7/8"
- ID 1 3/8"

Packing Dimensions (L x W x H)	Weight
Arm: 45 x 20 x 7	14 lbs.
Head: 14 x 14 x 9	6 lbs.
Ceiling Kit : 15 x 15 x 9	13 lbs.

Packing Dimensions (L x W x H)	Weight
Post 52": 57 x 3 x 3	13 lbs.
Post 68": 73 x 3 x 3	19 lbs.



# Luminous

*LED Operatory Light  
with PoliBlock Filter*



Luminous light handles are removable and sterilizable

#LP48-RI Light Post must be ordered if dental light is ordered separately  
**Specifications:**

Absorbed Power:	Max 8vA	Light intensity (Lux):	3,000 - 35,000 Lux @ 700mm
Input voltage:	110V/220V, 60/50 Hz	Cooling System:	Static Heat sink (no fan)
Output voltage:	24 Volts AC / DC	Illumination area:	100mm x 180mm @ 700mm
Bulb type:	LED		

Description	Model	Suggested Retail Price
Luminous LED Operatory Light	L-7601-LED	\$2,450
Luminous LED Operatory Light Sensor	L-7605-LED	\$2,650
Luminous LED Operatory Light Ceiling Mount	L-7901-LED	\$3,700

**Package includes the following:**

Input voltage 110V - 240 Vac	✓
2 year warranty	✓

**Options:**

**Nylon Bushing**  
 #LP-RI-S Included with models  
 • OD 1 7/8" R6101-LED, R6105-LED  
 • ID 1 3/8" 

Packing Dimensions (L x W x H)	Weight
Light: 37" x 16" x 15"	18 lbs.

# Mobile Cabinet Systems



**Utility Mobile Cabinet**  
#TMC-180

- 14.5" W x 16" D x 32" H
- designed for ultrasonic scalers, curing lights, electrasurge, intraoral cameras, etc.
- 1 instrument drawer
- 2 adjustable shelves
- 1 year warranty
- shipping dimensions: 24" x 24" x 37" / 72 lbs.



**Doctor's Mobile Cabinet**  
#TMC-140

- 21.5" W x 19" D x 32" H
- 4 instrument drawers
- 3 storage drawers
- 1 year warranty
- shipping dimensions: 27" x 25" x 36" / 116 lbs.



**Assistant's "Alabama" Mobile Cabinet**  
#TMC-160

- 21.5" W x 19" D x 32" H
- sliding counter top with amalgamator well
- 1 instrument drawer
- 2 storage drawers
- side to side sliding counter
- 1 year warranty
- shipping dimensions: 25" x 23" x 35" / 89 lbs.



**Assistant's "North Carolina" Mobile Cabinet**  
#TMC-120

- 21.5" W x 19" D x 32" H
- solid top with pull handle
- amalgamator well drop leaf door
- 3 instrument drawers
- 1 storage drawer
- 1 year warranty
- shipping dimensions: 25" x 23" x 36" / 112 lbs.



- White will be shipped if color choice not indicated on purchase order
- Mobile cabinets ship on pallet via freight carrier

Description	Model (light grey)	Model (white)	Suggested Retail Price
Utility Mobile Cabinet	TMC-180-G	TMC-180-W	\$340
Doctor's Mobile Cabinet	TMC-140-G	TMC-140-W	\$720
Assistant's "Alabama" Mobile Cabinet	TMC-160-G	TMC-160-W	\$720
Assistant's "North Carolina" Mobile Cabinet	TMC-120-G	TMC-120-W	\$720
Assistant's "North Carolina" Mobile Cabinet RT pull out		TMC-120R-W	\$720

**Package includes the following:**

External surfaces of high pressure laminate with complimentary white interior surface for easy cleaning. Smooth flowing ball bearing glides. Durable casters. Color choice: white or light grey. 1 year warranty



# 17" LCD Monitor

## Multimedia Monitor

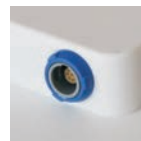

Intraoral Camera Port



Multimedia Input port

- Multimedia Monitor
- Glass panel
- 4:3 Screen
- DVD, Intraoral Camera READY!!
- Full 17" viewable TFT Active Matrix flat panel display
- Auto adjustment function
- Built-in dual speakers
- On screen display controls (OSDC)
- Recommended resolution: 1280 x 1024 (17")
- Universal 100-240 VAC, 50/60 Hz
- Gross weight: 11.6 lbs
- Includes: AC adapter, remote control, Monitor Handle, Camera Holder
- Connections: Video-in, HDMI, RGA-in, audio-in, DC-in, Flash Drive Media Player
- 1 year warranty

### Description

17" LCD multi media monitor

### Model

M017

### Suggested Retail Price

\$500

Shipping Dimensions 17" Monitor: 18" x 6" x 21" / 12 lbs.  
(2/cs.) 19" x 12" x 22" / 27 lbs.

# LCD Monitor Brackets

## Monitor Brackets



WIC800



WIC825



WIC840

### Standard LCD Monitor Bracket

- easily position the angle of your monitor for maximum comfort and productivity
- 4-way pivot adjustment
- standard 75mm spacing
- 1 Year warranty

Packing Dimensions:  
11" x 7" x 6" 6 lbs.  
(4/cs.) 15" x 12" x 11" 25 lbs.

### Deluxe LCD Monitor Bracket

- 16" extension arm
- vertical and horizontal travel
- 4-way pivot adjustment
- standard 75mm spacing
- 1 Year warranty

Packing Dimensions:  
14" x 12" x 6" 12 lbs.



### Mirage Monitor Bracket

- 16" extension arm
- horizontal travel
- 4-way pivot adjustment
- standard 75mm spacing
- 1 Year warranty

Packing Dimensions:  
15" x 10" x 5" 9 lbs.

WIC875



Monitor Adapter for AdvanceCAM Intraoral Camera & Docking Station

WIC865



Standard and Deluxe  
LCD Monitor Bracket  
may be wall mounted

- 1 year warranty

M100mm



Expansion Plate  
for 100mm Spacing

- 1 year warranty

Description	Model	Suggested Retail Price
Standard LCD Monitor Bracket	WIC800	\$118
Deluxe LCD Monitor Bracket with 16" Extension Arm	WIC825	\$360
Mirage LCD Monitor Bracket with 16" Extension Arm	WIC840	\$190
Expansion Plate for 100 mm spacing pattern	M100mm	\$22
Wall Plate Adapter	WIC865	\$90
Monitor Adapter for AdvanceCAM Intraoral Camera & Docking Station	WIC875	\$80

# Super Thin

## LED X-Ray Viewer

XV100 Viewer and  
XV150-R Bracket

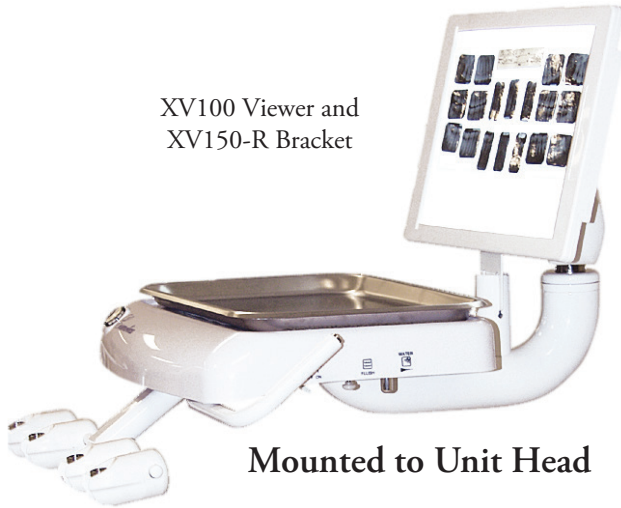

Mounted to Unit Head



Countertop Unit

- Viewing Area: 8.5" H x 11" W x 0.5" Thick
- Countertop, wall, or unit head mounted
- AC power source
- Sealed LED lights
- Instant illumination
- No grey in viewing area
- Viewing area accepts panoramic, cephalometric and regular size film
- 0.5" super thin viewer
- 1 year warranty



Wall Mounted

XV150  
Assembly



XV150-R  
\*Mount to TPC  
Mirage Unit (Round Arm)

XV150-F  
\*Mount to Flat Arm

### Description

### Model

### Suggested Retail Price

Super Thin X-ray Viewer

XV100

\$140

Package Dimensions: 17" x 11" x 2" / 3 lbs.  
(10/cs.) 17" x 11" x 19" / 28 lbs.

### Options:

### Retail

XV150-R Xray viewer bracket (round cut-out) – mount to Mirage unit head (Round Arm)

\$80.00

XV150-F Xray viewer bracket (flat cut-out) – mount to unit head (Flat Arm)

\$80.00

XV130 Replacement LED light strip

\$30.00

XV100-PSW Viewer replacement power supply

\$24.00

XV100-CLIP Viewer replacement Clip (3 Pack)

\$16.00



AIC5899



### Specifications

- Imager Sony 1/4" CCD
- Capture Size 640 X 480
- Light Source 6 White LEDs
- Power USB 5VDC
- Frame Rate 30 fps MAX
- PC connection USB 2.0 Port

### System Requirements

- Intel Pentium 4 .15 GHZ or Higher
- 512 MB RAM or higher
- Windows XP or higher
- USB 2.0 port



### Description

Corded Direct USB Camera System

### Model

AIC5899

### Suggested Retail Price

\$790

### Options:

- AIC500 Advance Cam Barriers, 500 / Box
- AIC930 Advance Cam Camera Holder
- AIC928-USB Advance Cam USB Camera Cable

### Retail

- \$170.00
- \$30.00
- \$63.00

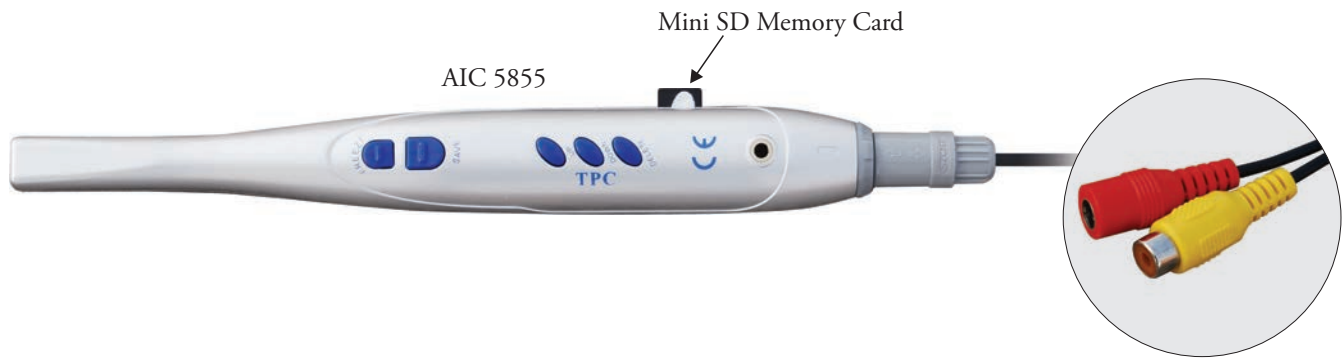

### Specifications

- Imager Sony 1/4" CCD
- Capture Size 640 X 480
- Light Source 6 White LEDs
- Power 5VDC
- Supported Mini SD Up to 16GB



Optional  
AIC500

### Description

Mini SD Card Camera System  
(Both Corded and Cordless)

### Model

AIC 5855-PKG  
(Includes: AIC5855+5901+5111)

### Suggested Retail Price

\$1,090

### Options:

- AIC5855 Advance Cam Intraoral Camera (Corded Only) with Mini SD Card
- AIC5901 Mini SD Cam Power Supply
- AIC500 Advance Cam Barriers, 500 / Box
- AIC5111 Camera Mounted LCD Display 2.5"

### Retail

\$760  
\$150  
\$170  
\$140



AIC5888

AIC5900

Optional  
AIC5111



AIC705  
(USB)



### Specifications

- Imager Sony 1/4" CCD
- Capture Size 640 X 480
- Light Source 6 White LEDs
- Power USB 5VDC
- Frame Rate 30 fps MAX
- PC connection USB 2.0 Port
- Power USB port 5V DC
- Frequency 2.4 Ghz

### System Requirements

- Intel Pentium 4 .15 GHZ or Higher
- 512 MB RAM or higher
- Windows XP or higher
- USB 2.0 port



### Description

Cordless USB Camera System

### Model

WL-USBCAM-PKG  
(Includes: AIC5888+705+5900)

### Suggested Retail Price

\$960

### Options:

		<b>Retail</b>
AIC5888	Advance Cam Intraoral Camera	\$680.00
AIC 705	Wireless USB Receiver	\$180.00
AIC 5900	Wireless Transmitter	\$196.00
AIC8.5v	Transmitter Charger	\$28.00
AIC5111	Camera Mounted LCD Display 2.5"	\$140.00
AIC500	Advance Cam Barriers, 500 / Box	\$170.00



### Specifications

- Imager Sony 1/4" CCD
- Capture Size 640 X 480
- Light Source 6 White LEDs
- Power USB 5VDC
- Frame Rate 30 fps MAX
- Connections AV & Composite VGA, HDMI
- Frequency 2.4 Ghz
- Memory Micro SD 4 gb

### System Requirements

- Intel Pentium 4 .15 GHZ or Higher
- 512 MB RAM or higher
- Windows XP or higher
- Optional: USB 2.0 port



### Description

Corded Camera & Docking Station System

### Model

AIC5888-5925W-KT (includes AIC5888+AIC5925)

### Suggested Retail Price

**\$1,130**

### Options:

		<b>Retail</b>
AIC5888	Advance Cam Intraoral Camera	\$680.00
AIC5925	Advance Cam Docking Station	\$520.00
AIC930	Advance Cam Camera holder	\$30.00
AIC5111	Camera Mounted LCD Display 2.5"	\$140.00
AIC500	Advance Cam Barriers, 500 / Box	\$170.00
AIC966	Wifi adaptor	\$150.00



### Specifications

- Imager Sony 1/4" CCD
- Capture Size 640 X 480
- Light Source 6 White LEDs
- Power USB 5VDC - 12VDC
- Frame Rate 30 fps MAX
- Connections USB, AV, Composite, VGA, HDMI
- Memory SD Memory Card 4 GB
- Frequency 5.8 Ghz



### Description

Cordless Camera & Docking Station System

### Model

WL-CAM+DS-PKG  
(Includes: AIC5888+5925W+5900+5920)

### Suggested Retail Price

\$1,380

### Options:

		Retail
AIC5888	Advance Cam Intraoral Camera	\$680.00
AIC5925	Advance Cam Docking Station	\$520.00
AIC 5900	Wireless Transmitter	\$196.00
AIC5111	Camera Mounted LCD Display 2.5"	\$140.00
AIC500	Advance Cam Barriers, 500 / Box	\$170.00
AIC5920	Wireless Receiver	\$140.00
AIC966	Wifi Adaptor	\$150.00

# 17" LCD Monitor

## Multimedia Monitor / Camera Combo

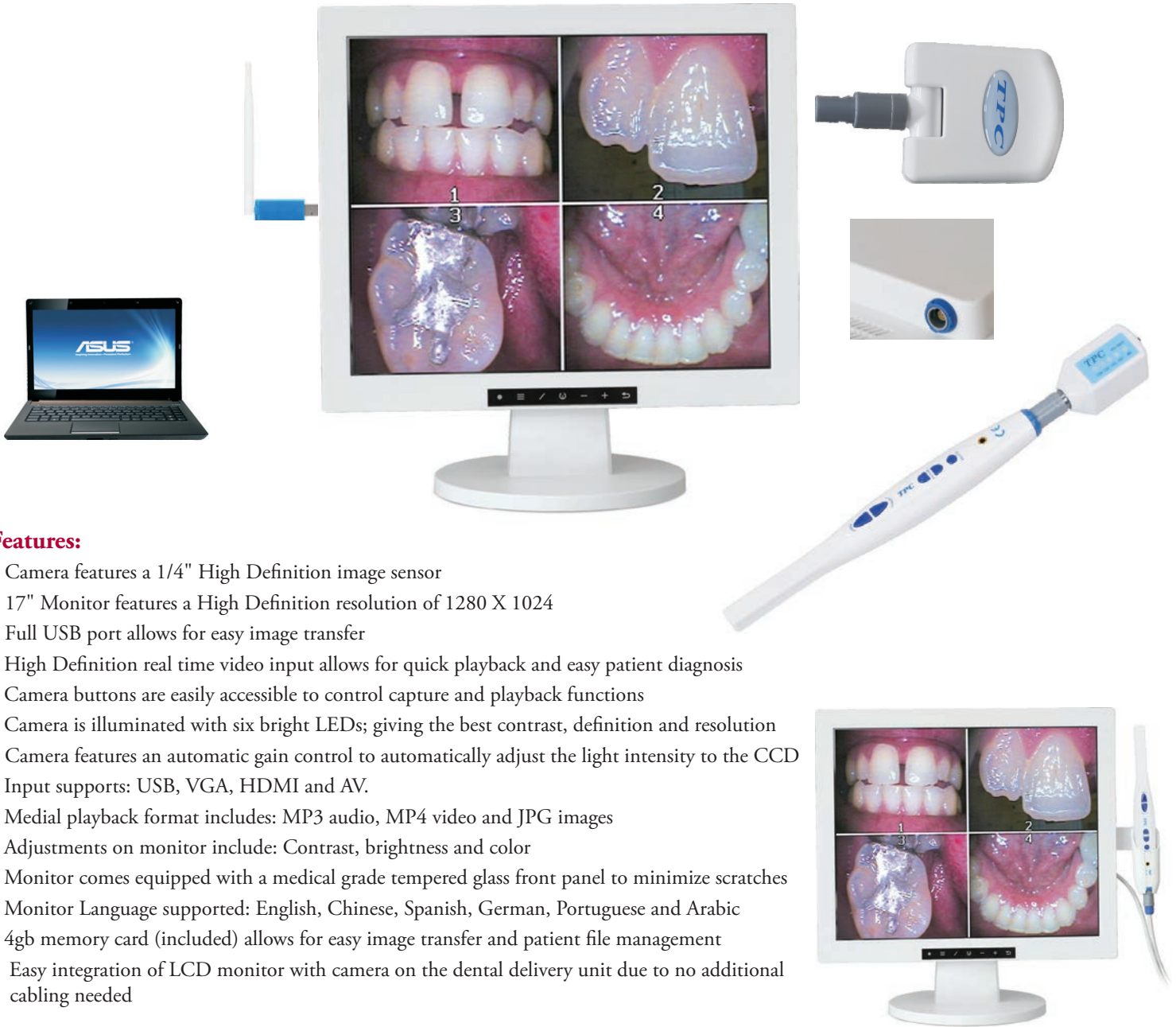

### Features:

- Camera features a 1/4" High Definition image sensor
- 17" Monitor features a High Definition resolution of 1280 X 1024
- Full USB port allows for easy image transfer
- High Definition real time video input allows for quick playback and easy patient diagnosis
- Camera buttons are easily accessible to control capture and playback functions
- Camera is illuminated with six bright LEDs; giving the best contrast, definition and resolution
- Camera features an automatic gain control to automatically adjust the light intensity to the CCD
- Input supports: USB, VGA, HDMI and AV.
- Medial playback format includes: MP3 audio, MP4 video and JPG images
- Adjustments on monitor include: Contrast, brightness and color
- Monitor comes equipped with a medical grade tempered glass front panel to minimize scratches
- Monitor Language supported: English, Chinese, Spanish, German, Portuguese and Arabic
- 4gb memory card (included) allows for easy image transfer and patient file management
- Easy integration of LCD monitor with camera on the dental delivery unit due to no additional cabling needed

### Description

### Model

### Suggested Retail Price

17" LCD monitor with integrated IO camera (**corded**)  
Includes: MO17, AIC5855A,  
17" LCD monitor with integrated IO camera (**wireless**)  
Includes: MO17, AIC5855A, AIC5920, AIC5900

AIC2IN1W  
AIC2IN1WL

\$1,200.00  
\$1,490.00

### Options:

### Retail

AIC500 Advance Cam Barriers, 500 / Box

\$170.00

Shipping Dimensions 17" Monitor: 18" x 6" x 21" / 12 lbs.  
(2/cs.) 19" x 12" x 22" / 27 lbs.

# 17" LCD Monitor

## Multimedia Monitor / Camera Combo



### Features:

- Camera features a 1/4" High Definition image sensor
- 17" Monitor features a High Definition resolution of 1280 X 1024
- Full USB port allows for easy image transfer
- Camera buttons are easily accessible to control capture and playback functions
- Camera is illuminated with six bright LEDs; giving the best contrast, definition and resolution
- Camera features an automatic gain control to automatically adjust the light intensity to the CCD
- 5.8 GHz wireless transmission protocol
- Four channel wireless transmitter (AIC5900) and receiver (AIC5920)
- Input supports: USB, VGA, HDMI and AV.
- Medial playback format includes: MP3 audio, MP4 video and JPG images
- Adjustments on monitor include: Contrast, brightness and color
- Monitor comes equipped with a medical grade tempered glass front panel to minimize scratches
- Monitor Language supported: English, Chinese, Spanish, German, Portuguese and Arabic
- 4gb memory card (included) allows for easy image transfer and patient file management
- Optional WIFI transmitter allows images to be displayed on stand alone LCD monitor and remote computers simultaneously for easy consultation and image management transfer.
- Easy integration of LCD monitor with camera on the dental delivery unit due to no additional cabling needed

Description	Model	Suggested Retail Price
17" LCD monitor with integrated IO camera corded Includes: MO17DS, AIC5888A	AIC3IN1W	\$1,500.00
17" LCD monitor with integrated IO camera wireless Includes: MO17DS, AIC5888 A, AIC5920, AIC5900	AIC3IN1WL	\$1,780.00

### Options:

		Retail
AIC500	Advance Cam Barriers, 500 / Box	\$170.00
AIC966	Wifi Adapter	\$150.00

Shipping Dimensions 17" Monitor: 18" x 6" x 21" / 12 lbs.  
(2/cs.) 19" x 12" x 22" / 27 lbs.

# EMC - 900

## eTornado Electric Motor System



### eTornado Electric Motor Features:

- Fiber Optic Brushless Electric Motor
- Two programmable settings for each mode
- Push Button control for easy operation
- Light weight, compact - ergonomical design
- Counter top system is easy to install and integrate
- Universal e-type connector compatible with most
- Speed range from 100 - 200,000 rpm

### Specifications

- 2 General / Basic Endo Modes
- e-type attachment / coupling
- Manual reverse
- Unit Dimensions  
4.5"W X 5.25" D X 2.5"H
- Motor weight: 87 grams
- Motor Length: 50mm
- Input Voltage: 100 - 240 Vac
- Output Voltage: 30Vac

Easy to install and integrate with any dental unit.

<u>Description</u>	<u>Model</u>	<u>Suggested Retail Price</u>
e Tornado Electric Motor System - Counter top	EMC-900	\$1,900
Package includes the following:		
e Tornado Electric Motor System - Counter top	✓	
Power Pack	✓	
HP Tubing	✓	
E600 Electric Motor up to 40,000 rpm	✓	
<b>Options</b>		
EMA150-FG	1:5 Friction Grip Attachment	\$1,160
EMA110-CA	1:1 Contra Angle Attachment	\$1,060
EMP30	Power Supply 30Vac, 4A for control box	\$140.00

Shipping Dimensions: 11" x 11" x 5" / 5 lbs.



# EMB - 901

## eTornado Electric Motor System



Electric Motor With Tubing



eTornado Control Box



eTornado Touchpad

### eTornado Electric Motor Features:

- Fiber Optic Brushless Electric Motor
- Two programmable settings for each mode
- Push Button control for easy operation
- Light weight, compact - ergonomical design
- Built in system pre wired for easy installation
- Universal e-type connector compatible with most electric attachments
- Speed range from 100 - 200,000 rpm

### Specifications

- 2 General / Basic Endo Modes
- e-type attachment / coupling
- Manual reverse
- Unit Dimensions  
4.5"W X 5.25" D X 2.5"H
- Motor weight: 87 grams
- Motor Length: 50mm
- Input Voltage: 100 - 240 Vac

### Description

eTornado Built in Electric Motor System

### Model

EMB-901

### Suggested Retail Price

\$1,790

### Package includes the following:

- eTornado Electric Motor System - Built in
- Power Pack
- HP Tubing
- E600 Electric Motor up to 40,000 rpm

- ✓
- ✓
- ✓
- ✓

### Options

- EMA150-FG 1:5 Friction Grip Attachment
- EMA110-CA 1:1 Contra Angle Attachment

\$1,160  
\$1,060

Shipping Dimensions:

# EMA-150FG

*High Speed Contra Angle Attachment*



EMA-110 CA

EMA-150FG

Description	Model	Suggested Retail Price
1:5 Friction Grip Attachment	EMA-150FG	\$1,160
1:1 Contra Angle Attachment	EMA-110CA	\$1,060
<b>Package includes the following:</b>		
Push Button Auto Chuck	✓	
Quatro Water Spray	✓	
Speed Range up to 200,000 rpm	✓	
Attachment to electric motor w/ E-type connection	✓	
Max Lux of 32,000	✓	

Shipping Dimensions:

# High Speed Handpieces Overview

*All High Speed Handpieces Use Ceramic Bearings*

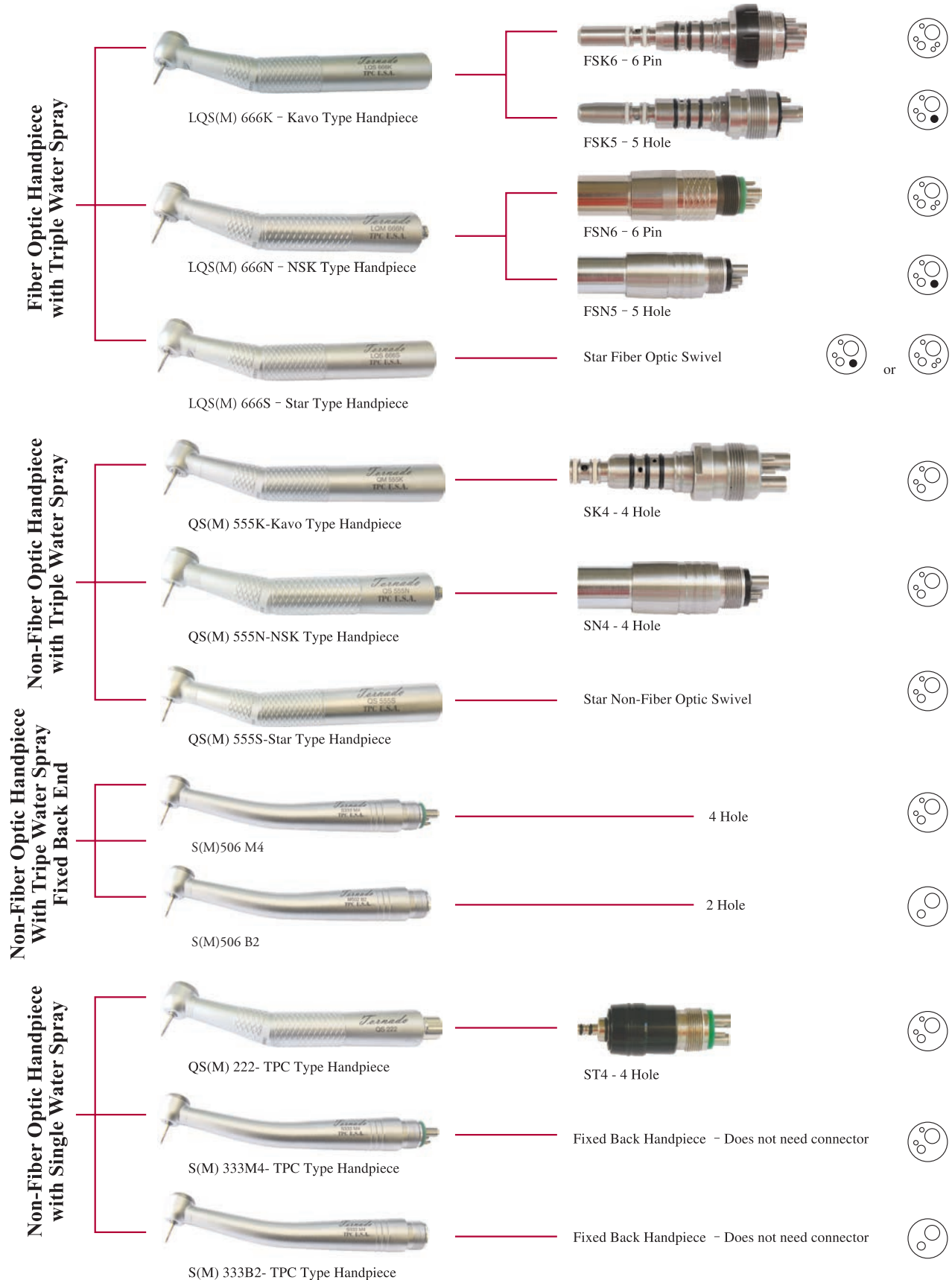

# Fiber Optic Handpieces

Triple Water Spray / Push Button / Auto Chuck / Ceramic Bearing

## Premius Series



Fiber Optic  
w/Triple  
Water Spray



LQS 666 (K,N,S)



Standard Head



LQM 666 (K,N,S)



Mini Head

## FIBER OPTIC QUICK CONNECTORS

(Swivel)



FSK6 Kavo Type 6 Pin



FSK5 Kavo Type 5 Hole



FSN6 NSK Type 6 Pin

Description	Model	Suggested Retail Price
Kavo Type Fiber Optic HP <u>Standard</u> Head w/Triple Water Spray Fits Kavo Connector	LQS666K	\$690
Kavo Type Fiber Optic HP <u>Mini</u> Head w/Triple Water Spray Fits Kavo Connector	LQM666K	\$690
6 Hole (ISO-C) Fiber Optic Connector Fits Handpiece with KAVO "Multiflex" Quick Connector System	FSK6	\$240
5 Hole (Midwest) Fiber Optic Connector Fits Handpiece with KAVO "Multiflex" Quick Connector System	FSK5	\$240
NSK Type Fiber Optic HP <u>Standard</u> Head w/Triple Water Spray Fits NSK Connector	LQS666N	\$690
NSK Type Fiber Optic HP <u>Mini</u> Head w/Triple Water Spray Fits NSK Connector	LQM666N	\$690
6 Hole (ISO-C) Fiber Optic Connector Fits Handpiece with NSK Quick Connector System	FSN6	\$240
Star Type Fiber Optic HP <u>Standard</u> Head w/Triple Water Spray Fits Star Connector	LQS666S	\$690
Star Type Fiber Optic HP <u>Mini</u> Head w/Triple Water Spray Fits Star Connector	LQM666S	\$690

# Non-Fiber Optic Handpieces

Triple Water Spray / Push Button / Auto Chuck / Ceramic Bearing

## Optimus Series



Non-Fiber Optic  
w/Triple  
Water Spray



QS 555 (K,N,S)



Standard Head



QM 555 (K,N,S)



Mini Head

## NON-FIBER OPTIC QUICK CONNECTORS

(Swivel)



SK4 Kavo Type 4 Hole



SN4 NSK Type 4 Hole

Description	Model	Suggested Retail Price
Kavo Type Non-Fiber Optic HP <u>Standard</u> Head w/Triple Water Spray Fits Kavo Connector	QS555K	\$520
Kavo Type Non-Fiber Optic HP <u>Mini</u> Head w/Triple Water Spray Fits Kavo Connector	QM555K	\$520
4 Hole Non-Fiber Optic Connector Fits Handpiece with KAVO "Multiflex" Quick Connector System	SK4	\$130
NSK Type Non-Fiber Optic HP <u>Standard</u> Head w/Triple Water Spray Fits NSK Connector	QS555N	\$520
NSK Type Non-Fiber Optic HP <u>Mini</u> Head w/Triple Water Spray Fits NSK Connector	QM555N	\$520
4 Hole Non-Fiber Optic Connector Fits Handpiece with NSK Quick Connector System	SN4	\$130
Star Type Non-Fiber Optic HP <u>Standard</u> Head w/Triple Water Spray Fits Star Connector	QS555S	\$520
Star Type Non-Fiber Optic HP <u>Mini</u> Head w/Triple Water Spray Fits Star Connector	QM555S	\$520

# Non-Fiber Optic Handpieces (Standard Back End)

Triple Water Spray / Push Button / Auto Chuck / Ceramic Bearing

## Triton Series



Non-Fiber Optic  
w/Triple  
Water Spray



S504 M4 / S506 M4



Standard Head



S504 M4 / M506 M4



Mini Head

Description	Model	Suggested Retail Price
Non-Fiber Optic HP <u>Standard</u> Head w/Triple Water Spray Standard Back End-4 Hole	S504M4 / S506M4	\$490
Non-Fiber Optic HP <u>Mini</u> Head w/Triple Water Spray Standard Back End-4 Hole	M504M4 / M506M4	\$490
Non-Fiber Optic HP <u>Standard</u> Head w/Triple Water Spray Standard Back End-2 Hole	S502B2	\$490
Non-Fiber Optic HP <u>Mini</u> Head w/Triple Water Spray Standard Back End-2 Hole	M502B2	\$490

# Non-Fiber Optic Handpieces

Single Water Spray / Push Button / Auto Chuck / Ceramic Bearing

## Nexius Series



Non-Fiber Optic  
w/Single  
Water Spray



QS 222 Standard Head



Standard Head



QM 222 Mini Head



Mini Head

## NON-FIBER OPTIC QUICK CONNECTORS (Swivel)



ST4 TPC Type 4 Hole

Description	Model	Suggested Retail Price
Non-Fiber Optic HP (Standard Head) with Single Water Spray Fits TPC Connector	QS222	\$440
Non-Fiber Optic HP (Mini Head) with Single Water Spray Fits TPC Connector	QM222	\$440
4 Hole Non-Fiber Optic Connector Fits Handpiece with TPC Quick Connector System	ST4	\$80

# Non-Fiber Optic Handpieces (Standard Back End)

Single Water Spray / Push Button / Auto Chuck / Ceramic Bearing

## Nexius Series



Non-Fiber Optic  
w/Single  
Water Spray



S333M4 Standard Head



Standard Head



M333M4 Mini Head



Mini Head

Description	Model	Suggested Retail Price
Push Button Autochuck (Standard Head) with Single Water Spray Standard Back End -4 Hole	S333M4	\$310
Push Button Autochuck (Mini Head) with Single Water Spray Standard Back End -4 Hole	M333M4	\$310
Push Button Autochuck (Standard Head) with Single Water Spray Standard Back End -2 Hole	S333B2	\$310
Push Button Autochuck (Mini Head) with Single Water Spray Standard Back End -2 Hole	M333B2	\$310



# Low Speed Handpieces

*External Water Coolant*

*Internal Water Coolant*

## Exomus Series



ELM 744: Air Motor, Speed range up to 20,000 rpm, forward / reverse speed adjustment



ELS 736: Transmission 1:1, speed range up to 20,000 rpm



ELCA 760: Transmission 1:1, push button autochuck, for latch burs



ELCA 762: Transmission 1:1, latch type, for latch burs

## Inximus Series



ILM 844: Air Motor, Speed range up to 20,000 rpm, forward / reverse speed adjustment, internal air/water coolant



ILS 836: Transmission 1:1, internal water spray



ILCA 860: Transmission 1:1, internal water spray, push button auto chuck for latch burs



### Description

### Model

### Suggested Retail Price

External Water Low Speed Complete package includes (air motor, straight nose cone HP, Push button contra angle HP)	ELK700-M4	\$748
External Water Low Speed Complete package includes (air motor, straight nose cone HP, Latch type contra angle HP)	ELK702-M4	\$618
Low Speed Motor, External Water, 20,000 rpm (4 hole)	ELM744-M4	\$320
Low Speed Motor, External Water, 20,000 rpm (2 hole)	ELM722-B2	\$320
Straight nose cone HP, 1:1	ELS736	\$178
Push button contra angle HP, Complete 1:1	ELCA-760	\$320
Latch type contra angle HP, Complete 1:1	ELCA-762	\$178
Internal Water Low Speed Complete package includes (air motor, straight nose cone HP, push button contra angle HP)	ILK800-4	\$1,360
Low Speed Motor (Internal Water) 20,000 rpm-4 hole	ILM844-4	\$500
Straight nose cone HP, 1:1	ILS836	\$480
Push Button Contra Angle HP, Complete 1:1	ILCA860	\$500

# Prophy Aide

*Hygiene Prophy Handpiece*



## Description

## Model

Prophy Aide Hygiene Handpiece  
 Prophy Aide Hygiene Handpiece  
**Package includes the following:**

PH-777 (Red) \$398  
 PH-777 (BLK) \$398

- 4 Hole fixed back end
- 5,000 RPM
- Twist open chuck
- 360 Head Swivel Capabilities
- Forward and Reverse operation

- ✓
- ✓
- ✓
- ✓
- ✓

# Fiber Optic Light Source

## Light Source Package



H 7070  
Fiber Optic Light Bulb  
Cartridge



H 7040  
Fiber Optic 5-Hole Tubing

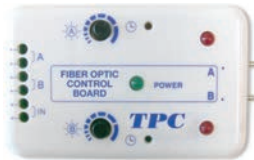

H 7020  
Control Board



H 7045  
Fiber Optic 6-Pin Tubing



H 7090  
Fiber Optic Transform



H 7660 - 6 Pin



H 7000 - 5 Hole

Package includes: H7020+H7045+H7090

Package includes: H7020+H7040+H7070+H7090

Description	Model	Suggested Retail Price
TPC Fiber Optic Light Source System- 6 Pin Package includes: Control board, Fiber Optic HP Tubing, Transformer	H7660	\$238
TPC Fiber Optic Light Source System- 5 Hole Package includes: Control board, Fiber Optic HP Tubing, Transformer, Bulb Cartridge	H7000	\$278
TPC Fiber Optic Control Board (accepts two Fiber Optic HP Tubing)	H7020	\$129
TPC Fiber Optic HP Tubing-6 Pin, Grey	H7045	\$108
TPC Fiber Optic HP Tubing- 5 Hole, Grey	H7040	\$108
TPC Fiber Optic Light Bulb Cartridge	H7070	\$50
TPC Fiber Optic Light Source Transformer	H7090	\$22

# Replacement Turbines & Parts

## Handpiece Replacement Parts

### REPLACEMENT TURBINES

Item #	Description	Retail
TRT 110S	Replacement turbine fits Tornado HP LQS 666, QS 555, Standard Head	\$250
TRT 115M	Replacement turbine fits Tornado HP LQM 666, QM 555, Mini Head	\$250
TRT 120S	Replacement turbine fits Tornado HP S333, Standard Head	\$218
TRT 122S	Replacement turbine fits Tornado HP QS222, Standard Head	\$218
TRT 125M	Replacement turbine fits Tornado HP QM222, M333, Mini Head	\$218
TRT 130	Push button turbine fits Kavo Super Torque 630 B/C and 640 B/C	\$250
TRT 135	Push button turbine fit for Kavo Super Torque 647B and 649 B	\$250
TRT 140	Push button turbine fit for Kavo Bella Torque 639B/C and 642 B/C	\$250
TRT 145	Push button turbine fit for Kavo Mira 635 B	\$250
TRT 150	Push button turbine fit for Star 430 Series Handpiece	\$250
TRT 155	Turbine fit for Midwest Quiet Air L F.O & Non F.O. HP	\$250
TRT 160	Turbine fit for Midwest Tradition L F.O & Non F.O. HP	\$250
TRT 165	Turbine fit for Midwest Tradition F.O & Non F.O. HP	\$130
TRT 170	Turbine fit for Midwest XGT/Tradition PB F.O & Non F.O. HP	\$250

### REPLACEMENT PARTS

Item #	Description	Retail
TRP 213	Replacement Light Bulb for FSK6 (Kavo Type Quick Connector)	\$27
TRP 215	Replacement Light Bulb for FSN6 (NSK Type Quick Connector)	\$27
TRP 220	Back Cap Removal Tool for LQS 666, QS 555	\$18
TRP 222	Back Cap Removal Tool for LQM 666, QM 555	\$18
TRP 224	Back Cap Removal Tool for QS 222	\$18
TRP 226	Back Cap Removal Tool for QM 222, M 333	\$18
TRP 228	Back Cap Removal Tool for S 333	\$7
TRP 231	Replacement Push Button Cap for LQS 666, QS 555	\$46
TRP 233	Replacement Push Button Cap for LQM 666, QM 555	\$46
TRP 235	Replacement Push Button Cap for QS 222	\$46
TRP 237	Replacement Push Button Cap for QM 222, M 333	\$46
TRP 239	Replacement Push Button Cap for S 333	\$46
TRP 240	Replacement O Ring for FSK6, FSK5, Sk4 (Pack of 5 (2 white, 3 black))	\$9.50

# H6000

## Handpiece Lubrication System

### Product Features

- Economical, efficient and time-saving
- A fail-safe maintenance solution for your office
- Filtered air used to rotate handpieces for safety
- Care for most handpieces and all handpieces brands
- Disposable mist filtration system
- Solution level indicator
- Detachable door for easy cleaning of unit
- Easy replenishment of solution tank
- Air Pressure guage
- Oil flow control valve



H6000  
(3 high speed positions)



### • Saves Time

#### • Simple to Operate

#### • Optimizes Performance



H6005

- 2 high speed positions
- 1 low speed E-type motor



H6025

- 1 high speed positions
- 2 low speed E-type motor



H6150-Kavo  
kavo maintenance coupler



H6155-NSK  
NSK maintenance coupler



H6165-W&H  
W&H maintenance coupler



H6145-MW  
Quick Connect for Midwest Slow Speed



H6160-BienAir  
BienAir maintenance coupler



H6175-E-Type  
4 Hole to E-Type Adaptor

Description	Model	Suggested Retail Price
H6000 Handpiece cleaning and lubrication system	H6000	\$1,250
H6005 Handpiece cleaning and lubrication system	H6005	\$1,300
H6025 Handpiece cleaning and lubrication system	H6025	\$1,350

### Package includes the following:

3 high speed handpiece positions	✓		
2 high speed / 1 low speed E-type Motor		✓	
1 high speed / 2 low speed E-type Motor			✓
Mist filters (pack of 12)	✓	✓	✓
Lubrication fluid	✓	✓	✓
Air filter	✓	✓	✓

### Options:

Options	Retail
H6125 Lubrication fluid	\$40.00
H6130 Mist filter (pack of 12)	\$20.00
H6135 Oil absorbent door strips (pack of 20)	\$16.00
H6150-Kavo Kavo Type HP adapter	\$102.50
H6155-NSK NSK Type HP adapter	\$102.50
H6160-BienAir Bien Air Type HP adapter	\$102.50
H6165-W&H W&H Type HP adapter	\$102.50
H6145-MW Quick Connect for Midwest Slow Speed	\$102.50
H6175-E-Type 4 Hole to E-Type Adaptor	\$102.50

Packing Dimensions: 17"L x 15"W x 18"H / 24 lbs.

# Advance 2500

## LED Bleaching System



Model #2500

### Features

- Quiet fan operation
- Multi-arch whitening application
- Three high intensity LED's
- Digital display with audio feedback
- High power Blue and UV light emitting diodes
- Compact mobile stand for easy storage
- Adjustable bleaching time with microprocessor-controlled timer
- Smart auto-select power: 110-240 Volts AC, 50/60 Hz
- LED bleaching system includes illuminator, mobile base, adjustable arm, power cord & user manual
- 1 year warranty

### Specifications:

Broad-spectrum:	395–490 nm
Light intensity:	1,500 mW/cm <sup>2</sup>
Weight:	14 lbs.
Dimensions:	60" (H) X 20" (W)
Voltage output:	110-240 V / 50-60 Hz
Packing Dimensions:	21" x 21" x 6" / 14lbs.

### Description

Advance 2500 LED Bleaching Light

### Model

ALED 2500

### Suggested Retail Price

\$1,300

### Package includes the following:

Advance 2500LED Bleaching Light	✓
Mobile stand	✓
AC power supply	✓
1 Year warranty	✓



# LED 70N

## Cordless Curing Light System



### Features

- Low battery signal – visual and audible alarm
- Easy to read – LCD display
- High light intensity – 5 to 10 second cure
- No down time
- Flexibility – corded and cordless light cure
- Quiet fan – extends life of LED
- Sleep mode – conserves power, saves battery life
- Fast mode – 3 output modes 2,000 – 1,500 – 1,000
- Built-in radiometer

### Specifications and Accessories

#### Switching Power Adapter

Power supply: AC 100-240V / 50-60 Hz  
 Dimensions: 10"L x 2"W x 8"H

#### Hand Piece

Light source: 10W light emitting diode  
 Wavelength: 430-490 nm  
 Light Intensity: 2,000 mW/cm<sup>2</sup>  
 Battery: Lithium ion

### Standard Accessories

- LED 70 Handpiece
- Charging base
- 8mm light guide
- Eye protector
- Lithium ion battery
- Power supply
- User's Manual

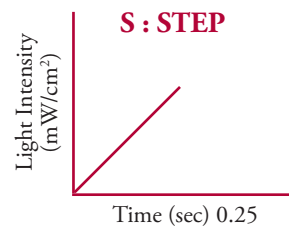
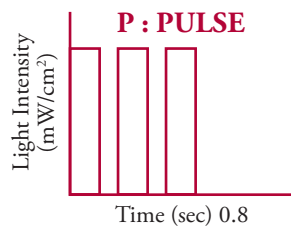
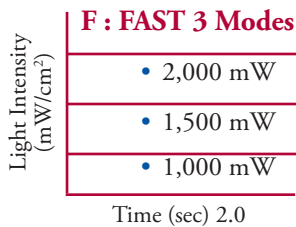

### Description

LED 70 Cordless Curing Light

### Model

ALED-70

### Suggested Retail Price

\$640

### Package includes the following:

- LED 70 Cordless Curing Light ✓
- Charging Base ✓
- Protective Eye-shield ✓
- Countertop Stand with Power Indicator ✓
- 8mm Light Guide ✓
- Built-in radiometer ✓
- AC power supply ✓

### Options:

		Retail
P109-LG	Replacement light guide (8mm)	\$78.00
P208	Replacement protective eye-shield	\$10.00
ALED 70N-BATT	Replacement rechargeable battery for LED 70	\$80.00
P117	11mm light guide	\$105.00

Shipping Dimensions: 11"L x 8"W x 4"H / 3 lbs.  
 (10/cs.) 18"L x 12"W x 16"H / 25 lbs.



# LED 60N

## Cordless Curing Light System



### Specifications and Accessories

#### Switching Power Adapter

Power supply: AC 100-240V / 50-60 Hz

Dimensions: 10"L x 2"W x 8"H

#### Hand Piece

Light source: 5W light emitting diode

Wavelength: 430-490 nm

Light Intensity: 1,400 mW/cm<sup>2</sup>

Battery: Lithium ion

### Features

- Low battery signal – visual and audible alarm
- Easy to read – LCD display
- High light intensity – 5 to 10 second cure
- No down time
- Flexibility – corded and cordless light cure
- Quiet fan – extends life of LED
- Sleep mode – conserves power, saves battery life
- Built-in radiometer

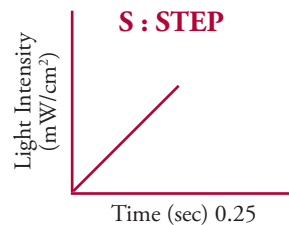
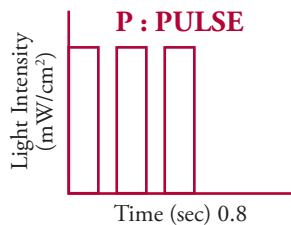
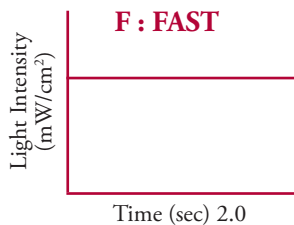

### Standard Accessories

- LED 60 Handpiece
- Charging base
- 8mm light guide
- Eye protector
- Lithium ion battery
- Power supply
- User's Manual

### Description

LED 60N Cordless Curing Light

### Model

ALED-60N

### Suggested Retail Price

\$490

### Package includes the following:

LED 60N Cordless Curing Light

Charging Base

Protective Eye-shield

Countertop Stand with Power Indicator

8mm Light Guide

Built-in power radiometer

AC power supply



### Options:

		<b>Retail</b>
P109-LG	Replacement light guide (8mm)	\$78.00
P219	Replacement protective eye-shield	\$10.00
ALED 60N-BATT	Replacement rechargeable battery for LED 60	\$60.00
P117	11mm light guide	\$105.00

Shipping Dimensions: 11"L x 8"W x 4"H / 3 lbs.  
(10/cs.) 18"L x 12"W x 17"H / 24 lbs.



# LED 55N

## Cordless LED Curing Light



### Specifications

- Battery: Lithium Ion, DC 3.6-4.2V
- Power adapter: 90-250V AC, 50-60 Hz
- Charging base: 9V DC
- Power consumption: 5 W LED
- Wavelength range: 430-490 nm
- Light Intensity: 1,250 mW / cm<sup>2</sup>
- Dimensions: 7"L x 1"W x 1"H
- Weight: 160 g
- Warranty: 2 year

### Benefits

- Ergonomic, light weight design
- High intensity output up to 1 hour before recharging
- Cordless for ultimate convenience
- Cures most materials in 5-10 seconds
- Curing time: 20 seconds per cycle with beep every 10 seconds
- 2 Batteries included.

### Charging Stand Light Indicators

LED color	Light Strength
Green	Normal
Orange	Light strength insufficient

### Curing Status Light Indicators

LED color	Status Indication
Green	Normal
Red	Battery Voltage Low
Red Flashing	LED curing light handpiece is over temperature

### Curing Mode Light Indicators

LED color	Working Mode
Green	Fast curing: Time setting 20 seconds (every 10 second, it sounds once)
Red	Pulse curing: interrupt radiating (every 10 seconds, it sounds once)
Orange	Step curing: soft start for 10 second from 0 to full power, then full power during the later 10 second



Charging Stand



ALED55N-1-G



ALED55N-1-R



ALED55N-1-B

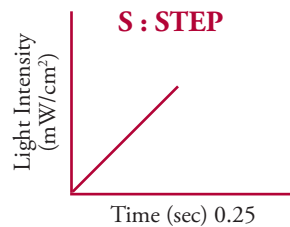
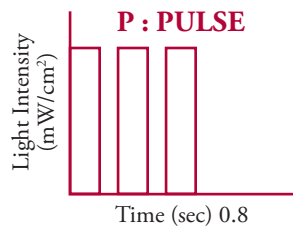
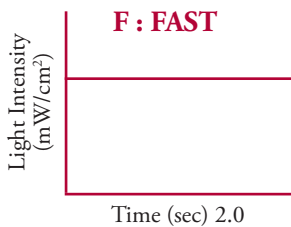

LM-300

### Description

- LED 55N Cordless Curing Light Silver
- LED 55N Cordless Curing Light Blue
- LED 55N Cordless Curing Light Red

### Model

- ALED55N-1-G Silver
- ALED55N-1-B Blue
- ALED55N-1-R Red

### Suggested Retail Price

- \$470
- \$470
- \$470

### Package includes the following:

- LED 55N Cordless Curing Light ✓
- Charging stand with power indicator ✓
- Protective Eye-Shield ✓
- AC Power Supply ✓

### Options:

Options:		Retail
P109-LG	Replacement Light Guide for LED 55 (8mm)	\$78.00
ALED55N-BATT	Replacement Battery	\$80.00
P219	Replacement Protective Eye-shield	\$10.00
P117	11mm Light Guide	\$105.00
LM300	Curing Light Meter	\$150.00

Shipping Dimensions: 10"L x 7"W x 4"H / 3 lbs.  
(10/cs.) 21"L x 11"W x 14"H / 24 lbs.

# LED 55BN

*Built-in Curing Light System*



## Specifications

- Wavelength range: 430-490 nm
- Light Intensity: 1,250 mW / cm<sup>2</sup>
- Warranty: 2 year
- Power consumption: 5 W LED

Model ALED55-BN



LM-300



## Curing Mode Light Indicators

LED color	Working Mode
Green	Fast curing: Time setting 20 seconds (every 10 second, it sounds once)
Red	Pulse curing: interrupt radiating (every 10 seconds, it sounds once)
Orange	Step curing: soft start for 10 second from 0 to full power, then full power during the later 10 second

## Curing Status Light Indicators

LED color	Status Indication
Green	Normal
Red Flashing	LED curing light handpiece is over temperature

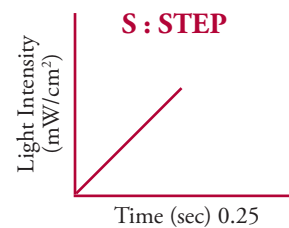
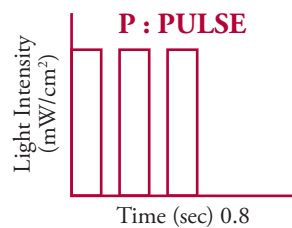
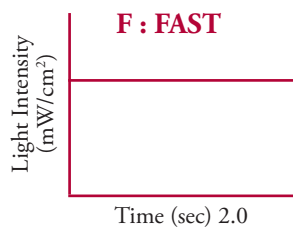

## Description

## Model

## Suggested Retail Price

LED 55BN Built-in Curing Light (LED 5W installed in dental unit)ALED55BN-A (110V - 240V)	\$390
LED 55BN Built-in Curing Light (LED 5W installed in dental unit)ALED55BN-E (24V)	\$390

## Package includes the following:

Turbo Light Guide	✓
Protective Eye-Shield	✓

## Options:

		Retail
P109-LG	Replacement light guide for LED 55B	\$78.00
P219	Replacement protective eye-shield	\$10.00
LED 55BN-PS110	Replacement Power Supply 110V - 240V	\$60.00
LED 55BN-PS24	Replacement Power Supply 24V	\$60.00
P117	11mm Light Guide	\$105.00
LM300	Curing Light Meter	\$150.00

Shipping Dimensions: 10"L x 6"W x 2"H / 2 lbs.  
(20/cs.) 21"L x 11"W x 12"H / 27 lbs.



# LED 50N

## Cordless Curing Light System

### Specifications and Accessories

#### Switching Power Adapter

Power supply: AC 100-240V / 50-60 Hz  
 Dimensions: 10"L x 2"W x 8"H

#### Hand Piece

Light source: 5W light emitting diode  
 Wavelength: 430-490 nm  
 Light Intensity: 800 - 1000 mW/cm<sup>2</sup>  
 Battery: Lithium ion

#### Standard Accessories

- LED 50N Handpiece
- Charging base
- 8mm light guide
- Eye protector
- Lithium ion battery
- Power supply
- User's Manual



LM-300



### Features

- Low battery signal – visual and audible alarm
- Easy to read – LCD display
- High light intensity – 5 to 10 second cure
- Flexibility – Cordless light cure
- Sleep mode – conserves power, saves battery life

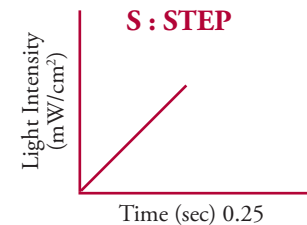
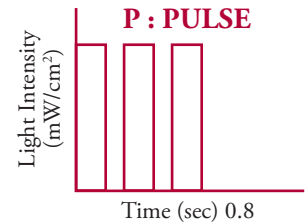
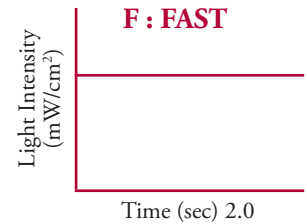

### Description

LED 50 Cordless Curing Light

#### Package includes the following:

- LED 50 Cordless Curing Light
- Charging Base
- Protective Eye-shield
- Countertop Stand with Power Indicator
- 8mm Light Guide
- Built-in power transformer
- AC power supply

### Model

ALED-50

### Suggested Retail Price

\$390

### Options:

- P109-LG Replacement light guide (8mm)
- P208 Replacement protective eye-shield
- LED 50-BATT Replacement rechargeable battery for LED 50
- P117 11mm Light Guide
- LM300 Curing Light Meter

### Retail

- \$78.00
- \$10.00
- \$63.00
- \$105.00
- \$150.00

Shipping Dimensions: 10"L x 8"W x 5"H / 2 lbs.  
 (10/cs.) 24"L x 10"W x 16"H / 20 lbs.

# LED 39N

## Curing Light System



### Specifications

- Class: Class II (ICE601-1)
- Wavelength range: 430-490 nm
- Light Intensity: 1,000 mW / cm<sup>2</sup>
- Warranty: 2 year

### Standard Accessories

- LED 39 Handpiece
- Stand
- 8mm Light Guide
- Eye protector
- Power supply
- User Manual



Built-in  
24 V Direct LED39BN



LM-300

### Curing Mode Light Indicators

LED color	Working Mode
Green	Fast curing: Time setting 20 seconds (every 10 second, it sounds once)
Red	Pulse curing: interrupt radiating (every 10 seconds, it sounds once)
Orange	Step curing: soft start for 10 second from 0 to full power, then full power during the later 10 second

### Curing Status Light Indicators

LED color	Status Indication
Green	Normal
Red Flashing	LED curing light handpiece is over temperature

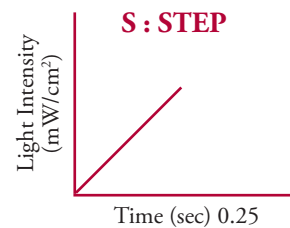
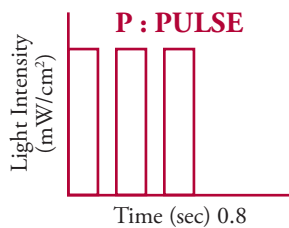
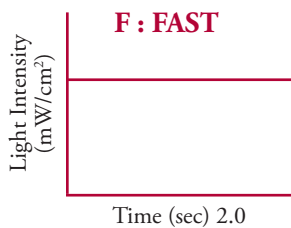

### Description

LED 39N Curing Light  
LED 39BN Curing Light

### Model

ALED 39N  
ALED 39BN (24V)

### Suggested Retail Price

\$360  
\$360

### Package includes the following:

LED 39 Curing Light	✓
8mm Light Guide	✓
Protective Eye-Shield	✓
Stand	✓
Built-in Power Transformer	✓

### Options:

P109	Replacement light guide for LED 39N	\$78.00
P219	Replacement protective eye-shield	\$10.00
ALED 39N-PS	Replacement Power Supply	\$42.00

Shipping Dimensions: 13"L x 7"W x 3"H / 2 lbs.  
(20/cs.) 24"L x 14"W x 14"H / 30 lbs.

# Power Light 150

## Halogen Curing Light



### Specifications

- Output light intensity: 500-600 mW/cm<sup>2</sup>
- Output wavelength range: 400-500 nm
- Preset curing times from 10 to 60 seconds or continuous cure
- LCD digital display
- Maintains constant light output and curing strength
- 8 mm light guide, protective eye shield and instruction manual included
- Powerful 75 Watt bulb
- Ultra quiet fan
- 1 year warranty (bulb excluded)

### Lighting Guides

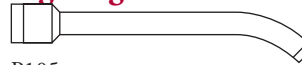

P105

8mm x 60°  
for general curing

Description	Model	Suggested Retail Price
Power Light 150 Halogen Curing Light	PL-150	\$370
<b>Package includes the following:</b>		
Power Light 150 curing light	✓	
8mm x 60° curing tip	✓	
Protective eye-shield	✓	
1 Year warranty	✓	
<b>Options:</b>		<b>Retail</b>
P105 8mm x 60 degree curing tip for general curing		\$78.00
P201 Replacement bulb, 12V, 75W		\$29.00

Shipping Dimensions: 13"L x 9"W x 7"H / 6 lbs.  
(5/cs.) 32"L x 14"W x 10"H / 30 lbs.

# Power Light 100



## Halogen Curing Light



### Specifications

- Output light intensity: 500-600 mW/cm<sup>2</sup>
- Output wavelength range: 400-500 nm
- Preset curing times from 10 to 60 seconds or continuous cure
- LCD digital display
- Maintains constant light output and curing strength
- 8 mm light guide, protective eye shield and instruction manual included
- Powerful 75 Watt bulb
- Ultra quiet fan
- 1 year warranty (bulb excluded)

### Lighting Guides

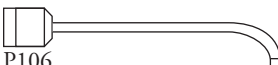
P101		13mm straight for large facial surface
P102		13mm x 80° for posterior occlusal curing
P103		8mm x 60° for general curing
P106		8mm - 3mm x 80° for layer curing of posterior restoration

### Description

Power Light 100 Halogen Curing Light

### Model

PL-100

### Suggested Retail Price

\$430

### Package includes the following:

Power Light 100 curing light	✓
8mm x 60° curing tip	✓
Protective eye-shield	✓
1 Year warranty	✓

### Options:

		Retail
P101	13mm straight curing tip for large facial surface	\$105.00
P102	13mm x 80 degree curing tip for posterior occlusal curing	\$105.00
P103	8mm x 60 degree curing tip for general curing	\$78.00
P106	3mm x 90 degree curing tip for layer curing of posterior restoration	\$105.00
P201	Replacement bulb, 12V, 75W	\$29.00
P203	Protective eye shield for Power Light 100	\$17.00
L0005	Blue light filter + heat absorber (set).	\$42.00

Shipping Dimensions: 12"L x 9"W x 6"H / 6 lbs.  
(4/cs.) 18"L x 13"W x 12"H / 26 lbs.

# LM300

## Curing Light Meter



### Description

LED Light Meter

### Model

LM-300

### Suggested Retail Price

\$150

### Package includes the following:

LED Light Meter



Battery



1 Year warranty



Shipping Dimensions: 8"L x 4"W x 2"H / 1 lbs.

# Advance 850LED

## LED Piezo Scaler w/Bottle System



### Standard Scaler Features

- Compact unit housing for easy placement anywhere in the operatory
- Extremely gentle on patient, causes little or no sensitivity
- No heat build up in handpiece tip with extended use
- Autoclavable handpiece
- Extensive power range to allow widest choice of clinical applications includes General, Perio and Endo
- Fine water spray eliminates excessive overspray onto patient
- Bottle water or External water source
- 5 tips included with unit
- Endodontic file holder & files included
- Easy and rapid operating for root canal treatment
- Achieve enlargement of canal quickly
- 1 year warranty

### Technical Data

- Absorbed Power: Max 15W
- Scaler: Max 10W, 24 -28kHz, automatic tuning
- Water Pressure: 30 - 145 PSI
- Water Consumption: 10 - 50 cc/min
- Approvals: ETL, according to UL - 2601 - 1
- Classification according to Medical Device
- Directive 93/42 EEC: Class 11a

Included tips



Endo file Holder



### Description

Advance 850-LED Piezo Ultrasonic Scaler & Endodontic Unit

### Model

A850-LED

### Suggested Retail Price

\$820

### Package includes the following:

Advance 850-LED piezo ultrasonic scaler with handpiece  
 G1, G2, G4, P4, P5 tips  
 Foot control  
 Tip wrench  
 Water Bottle  
 Endo file holder + files

✓  
 ✓  
 ✓  
 ✓  
 ✓  
 ✓

### Options:

A760 Endo files and holder (21mm #25)  
 A761 Piezo scaler tip #G1  
 A762 Piezo scaler tip #G2  
 A763 Piezo scaler tip #P3 Slim  
 A767 Piezo scaler tip #G4  
 A764 Piezo scaler tip #P4  
 A766 Piezo scaler tip #P5  
 A746 Piezo scaler handpiece w/ LED  
 A776 Tip wrench  
 A749 Piezo scaler O-rings (5 pack)  
 A778 Replacement Water line  
 A775 Replacement scaler foot control

### Retail

\$72.00  
 \$29.00  
 \$29.00  
 \$29.00  
 \$29.00  
 \$29.00  
 \$29.00  
 \$270.00  
 \$21.00  
 \$8.40  
 \$28.00  
 \$84.00

Shipping Dimensions: 18"L x 14"W x 5"H / 6 lbs.  
 (4/cs.) 18"L x 15"W x 21"H / 26 lbs.



# Advance 750LED

## LED Piezo Scaler

### Standard Scaler Features

- Compact unit housing for easy placement anywhere in the operatory
- intense LED Light Source
- Extremely gentle on patient, causes little or no sensitivity
- No heat build up in handpiece tip with extended use
- Autoclavable handpiece
- Extensive power range to allow widest choice of clinical applications
- Fine water spray eliminates excessive overspray onto patient
- Thin subgingival tips available
- 5 tips included with unit

### Optional Endodontics Unit Features

- Endodontic file holder
- Easy and rapid operating for root canal treatment
- Achieve enlargement of canal quickly

### Specifications

- Input rating: 115/230V, 50/60 Hz
- Dimensions: 160mm(W) x 155mm(D) x 70mm(H)
- Weight: 2.1 kg
- Frequency: 32 KHz
- Water pressure: 1-4 kg/cm<sup>2</sup>
- Fuses: 230V, 2 per unit ; F0.5A 250V-CQ-S500
- Fuses: 110V, 1 per unit ; F1A 5A 250V-CQ-S500
- 3 tips included with unit
- 1 year warranty (tips excluded)



Description	Model	Suggested Retail Price
Advance 750N Piezo Ultrasonic Scaler & Endodontic Unit	A750N	\$560
Advance 750N Piezo Ultrasonic Scaler & Endodontic Unit W/LED	A750LED	\$640

### Package includes the following:

Advance 750N piezo ultrasonic scaler with handpiece	✓	
#G1, #G2, #G3, #P4, #P5 tip	✓	✓
Foot control	✓	✓
Tip wrench	✓	✓
Advance 750 LED handpiece		✓

### Options:

	Retail
A760 Endo files and holder (21mm #25)	\$72.00
A761 Piezo scaler tip #G1	\$29.00
A762 Piezo scaler tip #G2	\$29.00
A763 Piezo scaler tip #P3 (slim)	\$29.00
A764 Piezo scaler tip #P4	\$29.00
A766 Piezo scaler tip #P5	\$29.00
A767 Piezo scaler tip #G4	\$29.00
A745 Piezo scaler handpiece	\$190.00
A746 Piezo sclaer handpiece w/LED	\$270.00
A776 Tip wrench	\$21.00
A749 Piezo scaler O-rings (5 pack)	\$8.40
A778 Replacement Water line	\$28.00
A775 Replacement scaler foot control	\$84.00

Shipping Dimensions: 13"L x 10"W x 5"H / 5 lbs.  
(8/cs.) 21"L x 14"W x 18"H / 42 lbs.

# Advance 800N

## Piezo Ultrasonic Built-In Scaler

A800N



A800LED



### Features

- Extremely gentle on patient, causes little or no sensitivity
- No heat build up in handpiece tip with extended use
- Autoclavable handpiece
- Extensive power range to allow widest choice of clinical application
- Fine water spray eliminates excessive overspray onto patient
- Thin subgingival tips available
- 5 tips included with unit
- 1 year warranty (tips excluded)

### Additional Benefits

- The Advance 800N eliminates the need for external water line and power cord connections
- The Advance 800N operates from unit foot control - no additional foot control needed
- The Advance 800N allows for a clean appearing operatory eliminating all visible tubes and power lines.

### Specifications

- Transformer: 24V, 1 amp
- Activated by unit foot control – no additional foot control needed
- Small electronic box, 2-3/8"L x 1.5"W x 1.25"H
- Easy tip system allows tips to be changed easily
- Absorbed power: max 15 watt
- Scaler: max 10 watt, 24-28 kHz, automatic tuning
- Water pressure: 30-145 PSI
- Water consumption: 10-50 cc/min
- No external water line / power cord
- 1 year warranty (tips excluded)

Description	Model	Suggested Retail Price
Advance 800N Piezo Ultrasonic Built In Scaler	A800N	\$490
Advance 800N Piezo Ultrasonic Built In Scaler W/LED	A800LED	\$570

### Package includes the following:

Advance 800N piezo ultrasonic scaler with handpiece	✓	
#G1, #G2, #G4, #P4, #P5 tip	✓	✓
Tip wrench	✓	✓
Transformer	✓	✓
Control box	✓	✓
Advance 800 LED handpiece		✓

Options:	Retail
A760 Endo files and holder (21mm #25)	\$72.00
A761 Piezo scaler tip #G1	\$29.00
A762 Piezo scaler tip #G2	\$29.00
A763 Piezo scaler tip #P3 (slim)	\$29.00
A764 Piezo scaler tip #P4	\$29.00
A766 Piezo scaler tip #P5	\$29.00
A767 Piezo scaler tip #G4	\$29.00
A745 Piezo scaler handpiece	\$190.00
A746 Piezo scaler handpiece w/LED	\$270.00
A776 Tip wrench	\$21.00
A749 Piezo Scaler O-rings (5 pack)	\$8.40

Shipping Dimensions: 9"L x 7"W x 4"H / 4 lbs.  
(10/cs.) 14"L x 10"W x 18"H / 40 lbs.

# PowerMAX25

## Ultrasonic Scaling System

Model PM25



### Features

- Available in 25Khz
- Precision automatic tuning circuitry
- Linear power control for exact power setting
- Accepts Cavitron®, P, SLI, TFI, and FSI scaler inserts
- Compact and lightweight
- Auto-ranging 110-240 VAC input
- Includes one ultrasonic scaler insert and foot control
- 1 year warranty

### Specifications

Weight: 6 lbs  
 Dimensions: 8"(W) x 8"(D) x 3"(H)  
 Output power to tip: Operator adjust approximately 10-40 watts  
 Handpiece cable: 7.5'  
 Power supply to unit: 110-240 VAC Input, 50/60 Hz  
 Water flow and supply pressure: 18 cc to 30 cc per minute flow from insert tip  
 Supply pressure to scaler is 25-60 PSIG city water or bottle system

Description	Model	Suggested Retail Price
PowerMAX25 Ultrasonic Scaler <b>with insert</b>	PM25	\$690

### Package includes the following:

PowerMAX ultrasonic scaler	✓
25K universal scaler insert	✓
Foot control	✓
1 year warranty	✓

### Options:

		Retail
S1025	25K universal insert-external water flow	\$70.00
S1030	30K universal insert- external water flow	\$70.00
S2025	25K universal slim insert- external water flow	\$70.00
S2030	30K universal slim insert- external water flow	\$70.00
S3025	25K universal insert- plastic handle- internal water flow	\$70.00
S3030	30K universal insert- plastic handle- internal water flow	\$70.00
S4025	25K universal slim insert- plastic handle- internal water flow	\$70.00
S4030	30K universal slim insert- plastic handle- internal water flow	\$70.00
S8001	25K Replacement handpiece w/ Tubing	\$100.00
PM775	Power Max replacement foot control	\$76.00
A778	Replacement water line 6' long with male quick disconnect (with shut off)	\$28.00

Shipping Dimensions: 12"L x 12"W x 4"H / 8 lbs.  
 (5/cs.) 18"L x 13"W x 14"H / 38 lbs.

# Ultrasonic Scaler Inserts



**#S1025**  
25K Universal Scaler Insert  
(metal handle)

**#S1030**  
30K Universal Scaler Insert  
(metal handle)

## Features

- External water
- Interchangeable for use with other brands of scalers
- 90 day warranty against defects arising from faulty materials or workmanship



**#S2025**  
25K Universal Slim Scaler Insert  
(metal handle)

**#S2030**  
30K Universal Slim Scaler Insert  
(metal handle)

## Features

- Slim tip design
- External water
- Interchangeable for use with other brands of scalers
- 90 day warranty against defects arising from faulty materials or workmanship



**#S3025**  
25K Universal Scaler Insert  
(plastic handle)

**#S3030**  
30K Universal Scaler Insert  
(plastic handle)

## Features

- Internal water delivery system delivers water directly to the insert tip and focuses it where it is needed most
- Large, round, non-slip plastic grip for greater tactile sensitivity, rotational control and reduced hand fatigue
- Better water management and less water usage means greater patient comfort
- Interchangeable for use with other brands of scalers
- 90 day warranty against defects arising from faulty materials or workmanship



**#S4025**  
25K Universal Slim Scaler Insert  
(plastic handle)

**#S4030**  
30K Universal Slim Scaler Insert  
(plastic handle)

## Features

- Internal water delivery system delivers water directly to the insert tip and focuses it where it is needed most
- Large, round, non-slip plastic grip for greater tactile sensitivity, rotational control and reduced hand fatigue
- Better water management and less water usage means greater patient comfort
- Interchangeable for use with other brands of scalers
- 90 day warranty against defects arising from faulty materials or workmanship

Model	Description	Retail
S1025	25K universal insert-external water flow	\$70.00
S1030	30K universal insert- external water flow	\$70.00
S2025	25K universal slim insert- external water flow	\$70.00
S2030	30K universal slim insert- external water flow	\$70.00
S3025	25K universal insert- plastic handle- internal water flow	\$70.00
S3030	30K universal insert- plastic handle- internal water flow	\$70.00
S4025	25K universal slim insert- plastic handle- internal water flow	\$70.00
S4030	30K universal slim insert- plastic handle- internal water flow	\$70.00
S8003	Ultrasonic Scaler insert O-rings (5 pack)	\$10.00

Shipping Dimensions: 9"L x 2"W x 1"H / 1 lbs.

# AS 5000

## Sonic Air Scaler



### Features

- Includes 3 tips AS1, AS2, AS3.
- Tip wrench included.
- Light weight
- Portable
- Saves time
- Autoclaveable
- Available in 2 or 4 hole.

Description	Model	Suggested Retail Price
Air Sonic Scaler -4 Hole Kit	AS5000-M4	\$270
Air Sonic Scaler -2 Hole Kit	AS5000-B2	\$270

### Package includes the following:

AS5000 Air sonic scaler handpiece	✓	✓
AS1 Universal Tip	✓	✓
AS2 Sickle Tip	✓	✓
AS3 Perio Tip	✓	✓
A776 Tip Wrench	✓	✓
6 Month warranty		

### Options:

	Retail
AS1 Universal Tip	\$24.00
AS2 Sickle Tip	\$24.00
AS3 Perio Tip	\$24.00

Shipping Dimensions: 9"L x 4"W x 2"H / 1 lbs.

# Air Polishing System

## Polishing System

### EZ Nozzle

- Carefully designed length, angle and curve of nozzle for applications to both anterior and posterior teeth. Allows for accurate direction of the power jet
- Includes two prophyl nozzles
- Handpiece nozzle is fully autoclavable up to 134 °C / 273 °F

### Ergo Comfort Design

- Fits comfortably in large and small hands. Notched grip allows firm and accurate tip control

### Lightweight & Flexible

### No Installation Cost

- Simply connects to handpiece tubing
- No extra foot control needed
- No external air or water connections needed

### Cleaning Power

- Jet Polishing powder (130g) has a refreshing lemon scent

### Powder Holder Covers

- Three translucent color coded holder covers are included (blue, green, purple)

### Quick Connection

- Simply pull back the quick release ring to release the nozzle from the handpiece



P560

Description	Model	Suggested Retail Price
Air Polishing System	P555-4H	\$240
Air Polishing System	P557-4H	\$280

### Package includes the following:

- |   |   |   |
|---|---|---|
| 1 – 130g of prophyl powder                              | ✓ | ✓ |
| 3 – color coded (red, blue, green) powder holder covers | ✓ | ✓ |
| 2 – nozzles (360 degree swivel)                         | ✓ | ✓ |
| 1 – cleaning tool                                       | ✓ | ✓ |
| 1 – O-ring set  | ✓ | ✓ |
| 1 year warranty   | ✓ | ✓ |

### Options:

	Retail
P560 130g of prophyl powder	\$14.00
P660 Nozzle for P555	\$50.00
P665 Nozzle for P557	\$60.00

Shipping Dimensions: 9"L x 8"W x 3"H / 2 lbs.  
(10/cs.) 13"L x 13"W x 10"H / 12 lbs.

# Ultrasonic Cleaner

*Dentsonic UC 400 / 1000*



Model UC-400

## Features

- Powerful 40 KHz of cavitation for thorough, quieter cleaning
- Stainless steel cover and tank with welded drain
- Durable vinyl clad steel housing is scratch resistant and easy to clean
- Digital timer for quick and easy process
- Sweep technology ensures exceptional cleaning efficiency
- 1 year warranty
- 2 tank sizes available 3.8 qt / 10.6qt
- Includes basket and lid

MODEL	UC-400	UC-1000
Input 115V	✗	✓
Input 230V	✓	✓
Frequency	50/60 Hz	50/60 Hz
Overall Dimensions L x W x H	10.6" x 6.3" x 9.5" 27cm x 16cm x 24cm	14.2" x 10.6" x 12.2" 36cm x 27cm x 31cm
Tank Internal Dimensions L x W x H	9.5" x 5.5" x 4" 24cm x 14cm x 10cm	11.8" x 9.5" x 5.9" 30cm x 24cm x 15cm
Ship Weight	10 lbs. 4.5 Kg	19 lbs. 8.6 Kg
Tank Capacity	3.8 Qts. / .95 Gallon 3.59 Liter	10.6 Qts. / 2.65 Gallon 10 Liter
Timer	LCD Display 1-99 minutes	LCD Display 1-99 minutes
302 StainlessSteel	✓	✓

UC-400 14 "L x 11"W x 3"H / 11 lbs.  
UC-1000 17 "L x 15"W x 16"H / 21 lbs.

Description	Model	Retail Price
UC-400 Ultrasonic Cleaner (3.8 qt.)	UC-400	\$570
UC-1000 Ultrasonic Cleaner (10.6 qt)	UC-1000	\$1080

## Package includes the following:

Ultrasonic cleaner	✓	✓
Stainless steel basket	✓	✓
Stainless steel lid	✓	✓
Drain kit	✓	✓
Timer	✓	✓

Options		Retail Price
UC400-BASKET	Replacement Basket (3.8 qt.)	\$72.00
UC1000-BASKET	Replacement Basket (10.6 qt)	\$115.00

# Dentsonic

## Ultrasonic Cleaner

### Features

- Powerful 35 KHz of cavitation for thorough, quieter cleaning
- Stainless steel tank
- Durable plastic housing is scratch resistant and easy to clean
- Digital timer for quick and easy process
- Sweep technology ensures exceptional cleaning efficiency
- 2 tank sizes available 2.5qt., 3.0qt.
- Includes basket and lid
- 1 year warranty



UC-250



UC-300



### Shipping Dimensions

UC-250	14"L x 11"W x 10"H / 8 lbs. (4/cs) 23L x 15W x 20H / 35lbs.
UC-300	20"L x 14"W x 12"H / 16 lbs. (2/cs) 20"L x 14"W x 24"H / 34Lbs

Model	UC-250	UC-300
Input 115Vac	✓	✓
Input 220Vac	✓	✓
Frequency	50/60 Hz	50/60 Hz
Overall dimensions	12.6" x 9.6" x 8.0"	17.5" x 10.8" x 8.1"
Tank Internal Dimensions	9.8" x 6.0" x 3.0"	9.8" x 7.0" x 3.0"
Shipping Weight	8 lbs	13 lbs
Tank Capacity	2.5 qt, 0.65 Gal, 2.46 L	3.0 qt, 0.8 Gal, 3.028 L
Digital Timer	LCD Display 1-30 min	LCD Display 1-30 min
302 Stainless Steel Tank	✓	✓

### Description

UC-250 Ultrasonic Cleaner 2.5 Qt  
UC-300 Ultrasonic Cleaner 3.0 Qt

UC-250

### Model

UC-300-S

### Suggested Retail Price

\$250

\$350

### Package includes the following:

Ultrasonic cleaner	✓	✓
Basket	✓	✓
lid	✓	✓
Drain kit	✓	✓
Digital timer	✓	✓
Heater	✓	✓



# Dentsonic

## Ultrasonic Cleaner

### Features

- Powerful 35 KHz of cavitation for thorough, quieter cleaning
- Stainless steel tank
- Durable plastic housing is scratch resistant and easy to clean
- Digital timer for quick and easy process
- Sweep technology ensures exceptional cleaning efficiency
- 2 tank sizes available
  - 1.6 Gallon
  - 2.0 Gallon
- Includes basket and lid
- 1 year warranty

UC-600



### Shipping Dimensions

UC-600 23 "L x 16"W x 14 "H / 23 lbs.  
 UC-750 24 "L x 16"W x 14"H / 27lbs.



UC-750

Model	UC-600	UC-750
Input 115Vac	✓	✓
Input 220Vac	✓	✓
Frequency	50/60 Hz	50/60 Hz
Overall dimensions	21.0" x 12.0" x 9.6"	21.3" x 13.3" x 10.9"
Tank Internal Dimensions	13" x 8.0" x 4.0"	13" x 9.4" x 4.1"
Shipping Weight	20 lbs	25 lbs
Tank Capacity	6.4 qt, 1.6 Gal, 6.056 L	8 qt, 2 Gal, 7.5 L
Digital Timer	LCD Display 1-30 min	LCD Display 1-30 min
302 Stainless Steel Tank	✓	✓

### Description

UC-600 Ultrasonic Cleaner 1.6 Gallon  
 UC-750 Ultrasonic Cleaner 2.0 Gallon

UC-600-S

### Model

UC-750

### Suggested Retail Price

\$600

\$798

### Package includes the following:

Ultrasonic cleaner	✓	✓
Basket	✓	✓
lid	✓	✓
Drain kit	✓	✓
Digital timer	✓	✓
Heater	✓	✓

# TPC Dentsonic Ultrasonic Cleaner

## Cassette Cross reference

851 South Lawson Street City of Industry CA 91748 • tpcdental.com • 800-560-8222

	UC-250	UC-300	UC-400	UC-600	UC-750	UC-1000
Tank Size (L x W x H)	9.6" x 5.9" x 3.0"	9.8" x 6.9" x 3.1"	9.5" x 5.5" x 4"	12.7" x 8.1" x 3.9"	12.5" x 9" x 3.5"	11.8" x 9.5" x 5.9"

<b>Hu-Friedy</b>						
Large Cassette 16-Instruments 8" x 11" x 1.25"				✓	✓	
Large Cassette 20-Instruments 4.5" x 8" x 1"			✓	✓	✓	✓
Small Cassette 8-Instruments 5.5" x 8" x 1.25"	✓	✓	✓	✓	✓	✓
Small Cassette 10-Instruments 5.5" x 8" x 1.25"	✓	✓	✓	✓	✓	✓
Exam Cassette 5-Instrument 3" x 8" x 1.25"	✓	✓	✓	✓	✓	✓
Space Saver 7-Instrument 4.5" x 8" x 1"	✓	✓	✓	✓	✓	✓
Double Decker Cassette 8-Inst. 3" x 8" x 1.5"	✓	✓	✓	✓	✓	✓
Double Decker Cassette 14-Inst. 4.5" x 8" x 1.5"	✓	✓	✓	✓	✓	✓
Double Decker Cassette 20-Inst. 6" x 9.7" x 1.5"		✓	✓	✓	✓	✓
Signa Stat Cassette 12-Inst. 6.5" x 10.5" x 1.25"				✓	✓	✓
Oral Surgery Cassette 12-Inst. 8" x 14.5" x 1.25"						
Radiography Cassette 4.5" x 8" x 1.5"		✓	✓	✓	✓	✓
Handpiece Cassette 3" x 8" x 1.25"	✓	✓	✓	✓	✓	✓
Ultrasonic Insert Cassette 1.5" x 8" x 1.25"	✓	✓	✓	✓	✓	✓

<b>Zirc</b>						
E-Z Jett Cassette 10-Place 7.93" x 7" x 1.125"				✓	✓	✓
E-Z Jett Cassette 8-Place 7.93" x 4.4375" x 1.125"	✓	✓	✓	✓	✓	✓
E-Z Jett Cassette 5-Place 8" x 3.125" x 1.1875"		✓	✓	✓	✓	✓
Compact Cassette 7.125" x 3.875" x 0.625"		✓	✓	✓	✓	✓
Mini Matt 3.875" x 3.5" x .5"	✓	✓	✓	✓	✓	✓
Instrument Mat 6.75" x 2" x 0.375"	✓	✓	✓	✓	✓	✓
Standard Steri-Container 8.125" x 1.875" x 1.875"	✓	✓	✓	✓	✓	✓
Compact Steri-Container 7.125" x 1.5" x 1.5"	✓	✓	✓	✓	✓	✓

**Warning:** There should absolutely be **NO** metal-metal contact inside of the tank during ultrasonic cycle  
**This includes No direct: Loose Instrument-to-Instrument, Cassette-to-Tank, Cassette-to-Cassette, Cassette-to-Basket; metal contact. Make sure Cassettes have standard silicone insulations and feet; if no basket is used.**  
 Tank Dimensions are measured **without** baskets; basket sizes vary depending on unit.  
 Please contact your cassette manufacturer or TPC if you have any questions.

# D650N

## Digital Amalgamator

Model D-650N



### Features

- ISO 9002 / ISO 13488 quality management certified
- Input voltage: 110V or 230V
- Touch pad selector
- Pre-programmed time settings
- Quiet, high-speed mix capsules
- Built-in automatic timer
- Accepts all capsules
- Customized trituration times
- Vibration frequency  $\geq$  4,400 RPMs
- 1 year warranty

### Description

D650 Digital Amalgamator

### Model

D-650N

### Suggested Retail Price

\$380

### Package includes the following:

D650 digital amalgamator

✓

AC power cord

✓

Shipping Dimensions: 13"L x 10"W x 10"H / 10 lbs.  
(2/cs.) 20"L x 14"W x 10"H / 20 lbs.

# N7

## Micromotor and Handpiece



### Features

- Powerful torque and variable speed motor
- No heat after long hours of operation
- Easy change of driving direction for efficiency
- Variable speed foot control
- Compact and ergonomic design
- Automatic stop with alarm beep and overload reset
- Includes control unit, motor handpiece and foot pedal
- 0–35,000 RPMs
- 110/220V ; 50/60Hz, 0.7A
- 1 year warranty

Description	Model	Suggested Retail Price
TPC Marathon N7 Micromotor and Handpiece	MM7	\$550
TPC Marathon N2 Micromotor and Handpiece	MM2	\$470

### Package includes the following:

N7 micromotor and handpiece	✓
AC power cord	✓
Foot pedal	✓

### Options:

		Retail
MM7-HP	Handpiece only with cable	\$330.00
MM7-MOTOR	Motor Control Box	\$330.00
MM7-VFC	Replacement Foot control	\$64.00
MM7-BR	Replacement Carbon Brushes	\$15.00

Shipping Dimensions: 11"L x 11"W x 5"H / 7 lbs.  
(8/cs.) 24"L x 12"W x 21"H / 58 lbs.

# Disposable Micro Applicators



• Four individual dispenser tubes included with each box

• 36 Boxes/case

Part No.	Description	Retail	1 Case	3+ Case
M6500-R	Disposable Micro Applicators, 400 ct. (Green / Orange)	\$17.50/Box	\$12.00/Box	\$10.00/Box
M6500-F	Disposable Micro Applicators, 400 ct. (Yellow / Blue)	\$17.50/Box	\$12.00/Box	\$10.00/Box
M6500-SF	Disposable Micro Applicators, 400 ct. (White / Purple)	\$17.50/Box	\$12.00/Box	\$10.00/Box
M6500-XSL	Disposable Micro Applicators, 400 ct. (Black)	\$17.50/Box	\$12.00/Box	\$10.00/Box

**Package includes the following:**

Four dispenser tubes, 100 brushes per tube

Shipping Dimensions: 4"L x 4"W x 5"H / 1 lbs.  
(36/cs.) 17"L x 13"W x 15"H / 35 lbs.

**Features**

- Non- linting fibers
- Bendable stiff tip
- Dispensing tubes eliminate the potential for cross contamination.

# Disposable Syringe Tips

## Description

P7700 Disposable White Syringe Tip  
 P7700-Bulk-refill (1600 pcs) Does not include dispenser

- Metal Interior
- 250 tips / box
- Syringe tip dispensers included (125 tips per dispenser)
- 36 boxes per case



## Retail

\$40.00/ box  
 \$192.00

## 1 Case

\$30.00/box

## 3+ Case

\$24.00/ box

## Features

- No adapter required fits most syringes (Unless converting from proprietary tip adapter)
- Interchangeable with metal syringe tip
- Available in a variety of bright colors
- Dispensing container reduces the risk of cross contamination

Shipping Dimensions: 6"L x 3"W x 4"H / 2 lbs.  
 36/cs 18"L x 13"W x 14"H / 48 lbs.  
 Bulk refill 40/cs 18"L x 10"W x 9"H / 33 lbs.

## Description

P7705 Disposable White Syringe Tip  
 P7705-Bulk-refill (1600 pcs) Does not include dispenser

- Plastic Interior
- 250 tips / box
- Syringe tip dispensers included (125 tips per dispenser)
- 36 boxes per case



## Retail

\$30.00/ box  
 \$140.00

## 1 Case

\$22.00/box

## 3+ Case

\$16.00/ box

## Features

- No adapter required fits most syringes (Unless converting from proprietary tip adapter)
- Interchangeable with metal syringe tip
- Available in a variety of bright colors
- Dispensing container reduces the risk of cross contamination

Shipping Dimensions: 6"L x 3"W x 4"H / 1 lbs.  
 36/cs 18"L x 13"W x 14"H / 32 lbs.  
 Bulk refill 40/cs 18"L x 10"W x 9"H / 18 lbs.

## Description

P7725 Rainbow Syringe Tip  
 P7725-Bulk-refill (1600 pcs) Does not include dispenser

- Rainbow colored interior tip
- 250 tips / box
- 2 Syringe tip dispensers included (125 tips per dispenser)
- 36 boxes per case



## Retail

\$30.00/ box  
 \$140.00

## 1 Case

\$22.00/box

## 3+ Case

\$16.00/ box

## Features

- No adapter required fits most syringes (Unless converting from proprietary tip adapter)
- Interchangeable with metal syringe tip
- Available in a variety of bright colors
- Dispensing container reduces the risk of cross contamination

Shipping Dimensions: 6"L x 3"W x 4"H / 1 lbs.  
 36/cs 18"L x 13"W x 14"H / 32 lbs.  
 Bulk refill 40/cs 18"L x 10"W x 9"H / 18 lbs.

# Disposable Prophylaxis Angles



(Purple Color / Soft Cup)

(Blue Color / Firm Cup)

- Latex free
- Individually packaged

- 20 Boxes/case PA144
- 8 Boxes/case PA500

Shipping Dimensions, Qty. **500:** 13"L x 11"W x 8"H / 4 lbs.  
(8/cs.) 22"L x 14"W x 32"H / 36 lbs.

Shipping Dimensions, Qty. **144:** 10"L x 7"W x 6"H / 1 lbs.  
(20/cs.) 20"L x 14"W x 29"H / 29 lbs.

Part No.	Description	Retail	1 Case	3+ Case
PA144-F	Disposable prophylaxis angles, 144 ct., Firm	\$58.00/Box	\$49.00/Box	\$45.00/Box
PA500-F	Disposable prophylaxis angles, 500 ct., Firm	\$188.00/Box	\$170.00/Box	\$150.00/Box
PA144-S	Disposable prophylaxis angles, 144 ct., Soft	\$58.00/Box	\$49.00/Box	\$45.00/Box
PA500-S	Disposable prophylaxis angles, 500 ct., Soft	\$188.00/Box	\$170.00/Box	\$150.00/Box

# Disposable Evacuator Tips



SAT-SW  
Small (25 tips / bag) White

Shipping Dimensions: 11"L x 7"W x 9"H / 5 lbs.  
(160/cs)23"L x 15"W x 18"H / 37 lbs.



SAT-LG  
Large (25 tips / Bag) Green

Shipping Dimensions: 11"L x 7"W x 9"H / 6 lbs.  
(160/cs)23"L x 15"W x 18"H / 46 lbs.

Part No.	Description	1 Box (20 Bags)	8 Box (160 Bags)
SAT-SW	Small Surgical Aspirator Tip (1/8") White	\$58.00	\$52.00
SAT-LG	Large Surgical Aspirator Tip (1/4") Green	\$66.00	\$60.00

**\*Minimum Order 1 box\***



HVE-1000  
(100 tips / bag) x 10 Bags

Shipping Dimensions: 12"L x 10"W x 10"H / 8 lbs.  
(40 bag/cs)20"L x 13"W x 21"H / 32 lbs.

Part No.	Description	1 box	+20 box
HVE-1000	High Volume Combo Tip (10 bags / box)	\$35.00/box	\$32.00/box



# Lab Products



2" Crown Box



1" Crown Box



Honey Comb Tray  
W/ Metal Pin



Honey Comb Tray  
W/ Ceramic Pin



Dowl Pin



Disposable Articulators  
Black

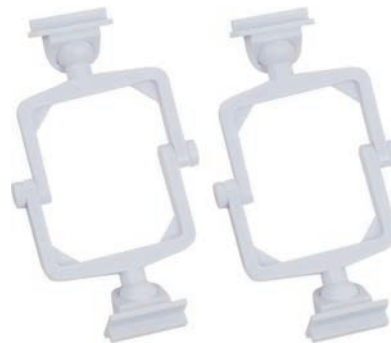

Disposable Articulators  
White

<b>Part No.</b>	<b>Description</b>	<b>Retail</b>
LAB-CRWBX-2	Plastic Crown Box W/ 2" Foam 500 / cs (Blue)	\$148.00
LAB-CRWBX-2BLK	Plastic Crown Box W/ 2" Foam 500 / cs (Black)	\$148.00
LAB-CRWBX-1	Plastic Crown Box W/ 1" Foam 1000 / cs (Blue)	\$182.50
LAB-CRWBX-1BLK	Plastic Crown Box W/ 1" Foam 1000 / cs (Black)	\$182.50
LAB-HC-MP	Honey Comb Tray W/ Metal Pin	\$11.30
LAB-HC-CP	Honey Comb Tray W/ Ceramic Pin	\$13.50
LAB-DP-M	Medium Dowl Pin 1000 / Bx	\$29.00
LAB-DART-WH	Disposable Articulators White 100 / Bag	\$17.50
LAB-DART-BLK	Disposable Articulators Black 100 / Bag	\$15.50

# Disposable Prophy Cups & Brushes



Description			Model	Retail
Latch type prophy brush	flat / white	pkg of 144	PB-300	\$38.00
Latch type prophy brush	flat / black	pkg of 144	PB-310	\$40.00
Screw-on type prophy brush	flat / white	pkg of 144	PB-320	\$36.00
Screw-on type prophy brush	pointed / white	pkg of 144	PB-330	\$36.00
Latch type prophy brush	pointed / white	pkg of 144	PB-340	\$38.00
Latch type prophy brush	pointed / black	pkg of 144	PB-350	\$40.00
Latch type prophy brush	cup shade / white	pkg of 100	PB-360	\$38.00
Latch type prophy brush	cup shade / bristle	pkg of 100	PB-370	\$42.00
Latch type prophy cup	webbed / white	pkg of 144	PC-505	\$22.00
Screw-on type prophy cup	webbed / white	pkg of 144	PC-515	\$25.00
Pointed-on prophy cup	webbed / white	pkg of 144	PC-525	\$25.00
Snap-on prophy cup	webbed / white	pkg of 144	PC-535	\$12.00

Shipping Dimensions: 4"L x 3"W x 2"H 1lbs.

**Alligator X-ray Film Holder - Straight**

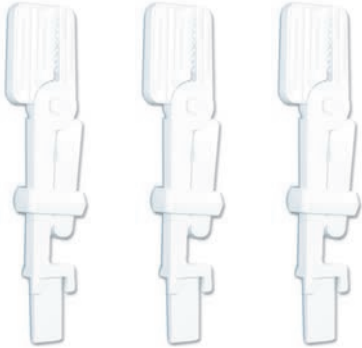

Part No.	Description	Retail
M7000-S	Alligator film holder (straight)	\$10.80

- Straight
- Box of 3

**Post Mount Utility Tray**

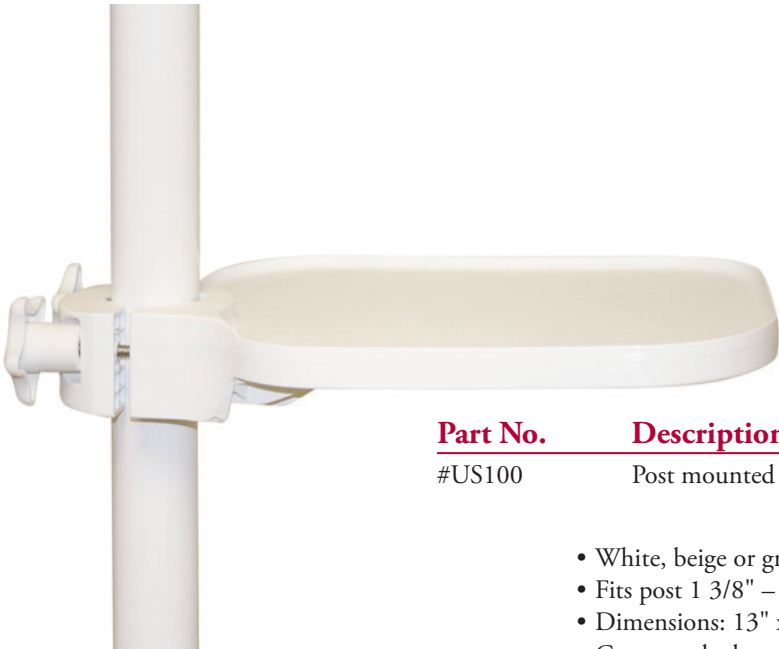

Part No.	Description	Retail	1 Case
#US100	Post mounted utility tray (specify color)	\$60.00	\$50.00

- White, beige or grey
- Fits post 1 3/8" – 2 1/2"
- Dimensions: 13" x 10"
- Contoured edge to contain spills and materials

• 20 Trays/Case

Shipping Dimensions: 17"L x 10"W x 3"H / 2 lbs.  
 (20/cs.) 25"L x 22"W x 18"H / 38 lbs.

# FILM MOUNTS

*Clear Pocket Mounts*

## Buy 3, Get 1 FREE!

Same Style Only

The ultimate in film protection, with clear pockets that hold all sizes, with full visibility.

All packages include 100 mounts each. All mounts are Buy 3, Get 1 FREE!

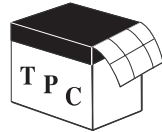

	<b>Catalogue #</b>	<b>Description</b>	<b>Retail Price</b>
	CP102U	Universal Select and Cut Roll of 500 Stripes of 2 mounts (1000 Windows)	<b>\$ 43.00</b>
	CP1C	One Window Convertible	<b>\$ 12.50</b>
	CP2H	Two Window Horizontal	<b>\$ 14.00</b>
	CP4C	Four Window Convertible	<b>\$ 19.00</b>
	CP4H	Four Window Horizontal	<b>\$ 19.00</b>
	CP6H	Six Window Horizontal	<b>\$ 20.50</b>
	CP4H2V	Six Window - 4 Horizontal - 2 Vertical	<b>\$ 21.50</b>
	CP8C	Eight Window Convertible	<b>\$ 25.50</b>
	CP8P	Eight Window Pedo 2H #2 6H#0	<b>\$ 27.00</b>
	CP10C	Ten Window Convertible	<b>\$ 30.00</b>
	CP8H6V	Fourteen Window - 8 Horizontal - 6 Vertical	<b>\$ 35.00</b>
	CP12H6V	Eighteen Window - 12 Horizontal - 6 Vertical	<b>\$ 40.00</b>
	CPTAG	Name Tag 100 / Pkg	<b>\$ 6.00</b>













# FILM MOUNTS

*Open Window Mounts*

**Buy 2, Get 1 FREE!**  
Same Style Only

Ten window film mounts provide excellent contrast for viewing.  
Safely store radiographs and films. Easy loading.

All packages include 100 mounts each. Open window mounts are Buy 2, Get 1 FREE!

	<b>Catalogue #</b>	<b>Description</b>	<b>Retail Price</b>
	W1H2	One Window Horizontal #2 Film	<b>\$ 12.00</b>
	W2H0	Two Window Horizontal #0 Film	<b>\$ 13.00</b>
	W2H2	Two Window Horizontal #2 Film	<b>\$ 13.00</b>
	W2H3	Two Window Horizontal #3 Film	<b>\$ 13.60</b>
	W4H0	Four Window Horizontal #0 Film	<b>\$ 18.50</b>
	W4H2	Four Window Horizontal #2 Film	<b>\$ 18.50</b>
	W4H2V2	Six Window - 4 Horizontal - 2 Vertical #2 Film	<b>\$ 22.00</b>
	W6H2	Six Window Horizontal #2 Film	<b>\$ 22.00</b>
	W8H2	Eight Window Horizontal #2 Film	<b>\$ 27.00</b>
	W8H6V2	Fourteen Window - 8 Horizontal - 6 Vertical #2 Film	<b>\$ 34.00</b>
	W12H6V2	Eighteen Window - 8 Horizontal - 6 Vertical - 4 BW #2 Film	<b>\$ 44.00</b>
	W10BW2	Ten Window BW #2 Film	<b>\$ 33.00</b>
	W20BW2	Twenty Window History Mount #2 Film	<b>\$ 56.00</b>

# FILM MOUNTS













## Notched Mounts

**Buy 2, Get 1 FREE!**

Same Style Only

Easy opening die cuts hold the film secure, while its thin profile requires minimum filing space. They are translucent for easy viewing.

All packages include 100 mounts each. Notched mounts are Buy 2, Get 1 FREE!

	<b>Catalogue #</b>	<b>Description</b>	<b>Retail Price</b>
	N1H2	One Window Horizontal #2 Film	<b>\$ 11.20</b>
	N2H0	Two Window Horizontal #0 Film	<b>\$ 12.00</b>
	N2H2	Two Window Horizontal #2 Film	<b>\$ 12.00</b>
	N2H3	Two Window Horizontal #3 Film	<b>\$ 13.00</b>
	N4H0	Four Window Horizontal #0 Film	<b>\$ 17.00</b>
	N4H2	Four Window Horizontal #2 Film	<b>\$ 17.00</b>
	N4H2V2	Six Window - 4 Horizontal - 2 Vertical #2 Film	<b>\$ 21.00</b>
	N6H2	Six Window Horizontal #2 Film	<b>\$ 21.00</b>
	N8H2	Eight Window Horizontal #2 Film	<b>\$ 27.50</b>
	N8H6V2	Fourteen Window - 8 Horizontal - 6 Vertical #2 Film	<b>\$ 34.00</b>
	N12H6V2	Eighteen Window - 8 Horizontal - 6 Vertical - 4 BW #2 Film	<b>\$ 44.00</b>
	N10BW2	Ten Window BW #2 Film	<b>\$ 33.00</b>
	N10BW3	Ten Window BW #3 Film	<b>\$ 33.00</b>

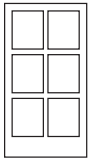

CLEAR POCKET MOUNT

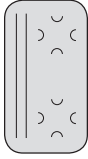

NOTCHED MOUNT

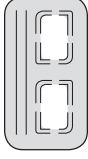

OPEN WINDOW MOUNT

# FILM MOUNT CROSS REFERENCE CHART

TPC			CASTERM		RINN			FLOW		ADA
POCKET	NOTCHED	WINDOW	POCKET	POCKET	POCKET	NOTCHED	WINDOW	NOTCHED	WINDOW	WINDOW
CP102U			N.A.	N.A.	20-0102					
CP8 PEDO			108 PEDO		N.A.			N.A.		N.A.
CP1C	N1H2	W1H2			20-1018	25-0178	30-6011	23200	601-200G	22004
	N2H0	W2H0			20-1024	25-0811	30-4021	23608	402-608G	22616
CP2H	N2H2	W2H2	102H		20-1020	25-0179	30-6021	23203	602-203G	22020
	N2H3	W2H3			20-1023	25-0180	30-7021	N.A.	702-206G	22061
	N4H0	W4H0			20-1044	25-0187	30-4040	23609	404-609G	22624
CP4C	N4H2	W4H2	104C		20-1048	25-0181	30-6040	23209	604-209G	22103
CP4H			104H		20-1040	25-0815	30-6045	23239	6045-239G	22152
CP4H2V	N4H2V2	W4H2V2	106HV		20-1062	25-1061	30-6062	23216	606-216G	22202
CP6H	N6H2	W6H2	106H		20-1060	25-0182	30-6061	23215	606-215G	22194
CP8C	N8H2	W8H2	108C		20-1088	25-0825	30-6081	23219	608-219G	22251
CP10C			110C		20-1108	N.A.	30-6101	23220	610-220G	22285
CP8H6V	N8H6V2	W8H6V2	114HV		20-1142	25-0184	30-6141	23225	614-225G	22335
CP12H6V	N12H6V2	W12H6V2	116-118HV		20-1182	25-0187	30-6180	23228	618-268G	22400
CP10C	N10BW2	W10BW2	110C		20-1108	25-0821	30-2345	23261	610-261G	22558
	N10BW3				N.A.	25-0820	30-3456	23262	N.A.	N.A.
		W20BW2			80-0138	N.A.	30-4567	N.A.	618-230G	22574

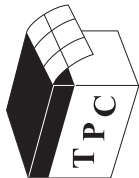

3-Way Syringe



Part No.	Description	Retail
#TPC3WAY	3-way syringe	\$42.00
#52046-TPC	Replacement Cartridge (2pcs per pack)	\$11.00

- 360° tip rotation
- Accurate air and water control
- Autoclavable quick disconnect aerator tip

3-Way Syringe Push Ring



Part No.	Description	Retail
TPC3WAY-PR	3-way syringe	\$53.90
#52046	Replacement Cartridge (2pcs per pack)	\$11.00

- 360° tip rotation
- Accurate air and water control
- Autoclavable quick disconnect aerator tip
- Quick connect push ring.

Autoclavable 3-Way Syringe Tip



Part No.	Description	Retail
#M7500	Autoclavable 3-way syringe tip (box of 100) (compatible with DCI 3-way syringe)	\$230.00/Box

- syringe tip only
- box of 100

Shipping Dimensions: 6"L x 4"W x 2"H / 2 lbs.



# Deluxe Autoclavable Valve

## Autoclavable High Vacuum Valve – Short



Part No.	Description	Retail
#P2330	Deluxe Autoclavable high volume ejector–short	\$33.00
#P2166	Replacement Deluxe HVE lever & spool	\$11.00

- Autoclavable valve
- Finger tip lever control for on/off flow
- Swivel quick disconnect for 360° rotation
- Adapts to 1/2" ID vacuum tubing
- Disconnect at swivel for simple autoclaving
- Anodized aluminum one piece valve body construction with anodized aluminum swivel

## Autoclavable High Vacuum Valve – Long



Part No.	Description	Retail
#P2335	Deluxe Autoclavable high volume ejector–long	\$35.00
#P2166	Replacement deluxe HVE lever & spool	\$11.00

- Autoclavable valve
- Ultra smooth lever control for on/off flow
- Swivel quick disconnect for 360° rotation
- Adapts to 1/2" ID vacuum tubing
- Disconnect at swivel for simple autoclaving
- Anodized aluminum one piece valve body construction with anodized aluminum swivel

## Autoclavable Saliva Ejector Valve



Part No.	Description	Retail
#P2340	Deluxe Autoclavable saliva ejector valve	\$27.00
#P2169	Replacement deluxe saliva ejector lever & spool	\$11.00
#P2185	Replacement deluxe saliva ejector rubber tip <u>only</u> (5 pcs/Bag)	\$9.90/Bag

- Autoclavable valve
- Ultra smooth lever control for on/off flow
- Swivel quick disconnect for 360 degree rotation
- Disconnect at swivel for simple autoclaving
- Anodized aluminum one piece valve body construction with anodized aluminum swivel



### Curing Bulb

- 12 Volt 75 Watt
- Power Light 100
- Replacement for PL100

#P201 \$ 29.00

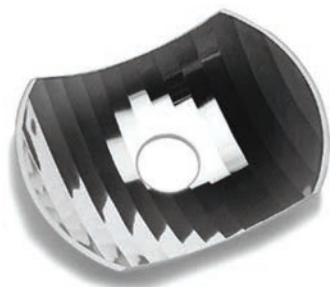

### Operator Light Reflector

- Quality coated glass
- No core charge
- Original factory OEM specifications
- Replacement reflector for Belmont®, LSM® and Celux lights

#P705 \$ 160.00



### Scaler Tubing 30K without Connector

- 30KHz 3-wire handpiece assembly
- Silicone jacket

#S8002 \$ 100.00



### Scaler Tubing 25K without Connector

- 25KHz 3-wire handpiece assembly
- 7' length

#S8001 \$ 100.00

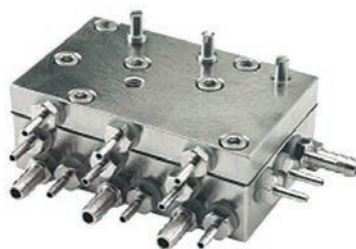

### Mini HP Control Block

- Mini control block for 3 handpieces
- Solid brass construction
- Extra mounting holes allow a variety of placements
- 10-32 threaded barbs
- Longest lasting inter-woven diaphragm
- High flow design

#52003 \$100.00

#52004 Diaphragm \$10.00



### Water Bottle System

- 750 ml Extra Heavy duty bottles
- Easy to read pressure gauge
- Pre-set integrated regulator
- Ideal for bactericidal solutions
- Post clamp
- Will mount to vertical surface

#W5030 \$125.00

#W5035 - 750 ml bottle only \$6.00

#W5040 - 1000 ml bottle only \$18.00

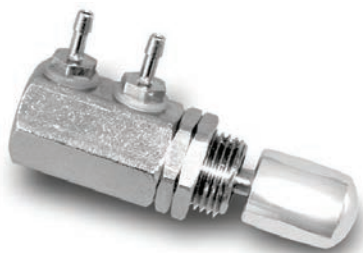

### Flow Control Valve

- Chrome plated brass

#52007 \$ 15.50



### Momentary Valve

- Chrome plated brass

#52008 \$ 13.00



### On/Off 2-Way Valve

- Chrome plated brass

#52009 \$ 13.00



### On / Off 3 Way Valve

- Chrome plated brass
- #52010 \$ 13.90



### Check Valve

- Chrome plated brass
- #52019 \$ 9.50



### Routing Valve

- Chrome plated brass
- #53014 \$ 15.00



### Non-Retraction Water Relay Valve

- Chrome plated brass
  - Equivalent to DCI #7068
- #52011 \$ 33.00



### 4-hole Adapter, Metal

- Quality plated brass
- #52039 \$ 8.00

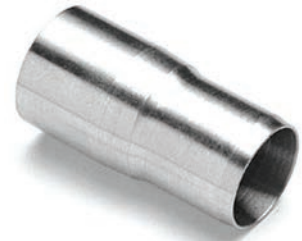

### Plated Brass Nut 4-hole Midwest

- Brass extends HP thread life
  - Standard connector
- #52040 \$ 3.50



### HP Tubing Adapter, 2 - hole HP to 4-hole Tubing

- Adapts 2 hole HP to 4-hole tubing
- #52041 \$ 39.00



### HP Tubing Adapter, 4-hole HP to 2 -hole Tubing

- Adapts 4-hole HP to 2-hole tubing
- #52042 \$ 39.00



### Stainless Steel Tray

- Premium quality stainless steel
  - Size 13F (9-3/4" x 13-1/2")
- #52026 \$ 39.00  
#52027 Skid Pad \$3.16

# Parts



## Female Quick Disconnect

- Panel mount with auto shut-off
- 1/4" poly-flow rear connection
- Chrome plated brass
- 1/4" Coupler

#53012 \$ 15.00



## Male Quick Disconnect w/ Shut-off

- With auto shut-off
- 1/4" poly-flow rear connection
- Chrome plated brass
- 1/8" Male QD

#53042 \$ 11.50



## Male Quick Disconnect w/ Shut-off

- With auto shut-off
- 3/8" poly-flow rear connection
- Chrome plated brass
- 3/8" male QD

#53043 \$15.70



## 1/4" Coupler with shut off

- barb type
- Chrome plated brass
- Equivalent to DCI #0006

#53047 \$ 10.00



## Foot Control, Wet/Dry

- Precision-touch disc foot control with wet/dry toggle
- Weighted for maximum stability
- Durable chrome steel dome
- Smooth, variable pressure control
- Non-skid foot pads

#53200 \$ 95.00

#53200-TS Toggle (only) \$1.60

#53121 Toggle assembly \$19.90



## Foot Control, Shrouded

- Large stable base with shroud
- Precision-touch disc foot control
- Weighted for maximum stability
- Durable chrome steel dome
- Smooth, variable pressure control
- Non-skid foot pads

#53117 \$ 65.00



## 4 Hole HP Straight Asepsis Assembled

- Assembled with metal adapter / nut
- Silicone Jacket
- 5.5' length

#52036 \$25.00



## Syringe Tubing

#52038 \$16.50

- 6' Silicone Jacket tubing



## Air Electric Switch

- Normally open air switch
- 15 PSI activated Check this spec

#A800N-SW \$ 19.00

# Parts



53016-S

53016-L

## Disposable Amalgam Traps

- 53016-S-100 1 7/8" Clear
  - 53016-L-100 2 1/8" Clear
  - Clear trap pkg of 100
- #53016-S-100 **\$45.00**  
 #53016-L-100 **\$45.00**



## Solids Collector Canister

- Includes: Lid, Base, o-ring
  - Bottom ported 2015 unit
  - 2 1/8" trap
- #53008 **\$42.00**



## Solids Collector Canister

- Includes: Lid, Base, o-ring
  - Side ported for 3550 unit
  - 2 1/8" trap
- #53008-R **\$42.00**



## Solids Collector Canister

- Includes: Lid, Base, o-ring
  - Bottom ported, 2600 unit
  - 1 7/8" trap
- #53008-2600 **\$42.00**



## Nylon Bushing

- #LP-RI-S **\$20.00**
- OD 1 7/8"
  - ID 1 3/8"



## Nylon Bushing

- #LP-PC-L **\$20.00**
- OD 1 7/8"
  - ID 1 11/16"



## Chair Adaptor

- #TPCRDSBKT **\$ 330**
- TPC Mirage swing mount chair bracket



## Chair Adaptor

- #L2000-BKT **\$ 270**
- Laguna chair bracket

## 48" Light Post

- #LP48 **\$149.00**
- 48" light post
  - LP-PC-L included
  - Optional: LP-RI-S



## Chair Adaptor

- #BELBRKT **\$ 165.00**
- Belmont Chair Bracket
  - Fits Bel 20 and 50 chairs



## Chair Adaptor

- #TPCBRKT **\$ 270**
- TPC chair bracket
  - RT handed setup



## Chair Adaptor

- #TPCBRKT -L **\$ 270**
- TPC chair bracket
  - LF handed setup

# Custom Umbilical Lengths / Utility Center

## 2000 / 2015 Umbilical

- 1 (6 X 4) MM Air "Yellow"
  - 1 (6 X 4) MM Water "Blue"
  - 4 (4 X 2.7mm)
    - Yellow
    - Grey
    - Purple
    - Red
  - 1 (5/8") Drain Line
  - 1 (5/8") Cuspidor Drain 2000 unit
  - 1 (2") Umbilical
  - No Electrical / Low Voltage
- #2015-UMB-FT **\$ 31.50**  
 #2015-UMB-10 **\$283.50** 10' length

## 3500 Umbilical

- 1 (6X4) MM Air "Black"
  - 9 (4 X 2.7mm)
    - Yellow
    - Grey
    - Purple
    - Red
    - Green
    - Blue
    - Maroon
    - Black (spare)
    - Red (spare)
  - No Low Voltage
- #3500-UMB-FT **\$ 31.50**

## 3550 Umbilical

- 1 (6X4)mm Air "Yellow"
  - 1/2" Sprial Loc Tubing
  - Syringe tubing.
- #3550-UMB-FT **\$19.00**

## MC500 / 501 Umbilical

- 1 6X4MM Air "Black"
  - (1 1/2") Umbilical
  - 8 4 X 2.7mm
    - Yellow
    - Grey
    - Red
    - Green
    - Blue
    - Maroon
    - Black (spare)
    - Red (spare)
    - Purple (spare)
  - 1/2" Sprial Lock Suction  
 MC501 only Add  
 \$2.62 per ft
  - Low Voltage
- #MC500-UMB-FT **\$ 31.50**

## OMC2375 Umbilical

- 1 6X4MM Air "Yellow"
  - 1 (1 1/2") Umbilical
  - 8 4 X 2.7mm
    - Yellow
    - Grey
    - Clear
    - 5/8" Sprial Lock Sction
  - No Electrical
- #OMC2375-UMB-FT **\$ 32.00**

## MS3000 / MR4000

- 1 6X4mm Air "Black"
  - 8 4 X 2.7mm
    - Yellow
    - Grey
    - Red
    - Green
    - Blue
    - Maroon
    - Black (spare)
    - Red (spare)
    - Purple (Spare)
  - No Low Voltage
- #3000-UMB-FT **\$ 31.50**

## Junction Box

- 12.5" X 12.5"
  - Metal frame
  - Plastic top cover
- #53120 **\$105.00**



## Master Shut-Off Valve

- Includes air / water valved
  - 3/8" compression tube
  - Includes pressure regulator
  - Includes pressure guage
- #53119 **\$204.76**



## Rebulid Kit for 53119

- Diaphragm
  - Spring
  - Plunger
- #53099 **\$13.00**



## 40 micron filter

- Use for air and water
  - 40 micron filter element
- #53107 **\$2.10**



## Raw Tubing per Ft.

Part Number	Description	Price per Ft
53096	1/2 Grey Sprial Lock Tubing	\$3.00 Per Ft
53093	5/8" Clear Sprial Lock Tubing	\$3.00 Per Ft
53085	5/8" Grey Sprial Lock Tubing	\$3.00 Per Ft
53021	2" Umbilical Tubing	\$6.20 Per Ft
2000-HVETubing	1/2" Smooth HVE tubing	\$2.50 Per Ft
2000-SETubing	Saliva Ejector Tubing	\$1.30 per Ft



*Advanced Technology, Inc.*  
"On budget.... On time!"

851 South Lawson Street, City of Industry CA 91748  
800-560-8222 (PH) 626-810-4245 (FX)

PURCHASE ORDER NO.	
--------------------	--

# PURCHASE ORDER

<b>TO:</b>		<b>SHIP TO:</b>	
Dealer		End User	

P.O. DATE	SHIP VIA	F.O.B.	TERMS			
BUYER	FREIGHT	REQ. DATE	CONFIRMING TO	REMARKS	TAX	
QTY. REQ.	UNITS	DESCRIPTION			UNIT COST	EXTENDED COST
		<b>TOTAL</b>				

Credit Card Number: \_\_\_\_\_ Date: \_\_\_\_\_  
 Expiration Date: \_\_\_\_\_ Code: \_\_\_\_\_  
 Authorized by: \_\_\_\_\_ Date: \_\_\_\_\_

Terms of Sale and Payment: Purchaser hereby authorizes TPC to ship the above equipment / supplies. The purchaser understands and agrees that the complete payment or this entire order is due prior to shipping order. Cancellatioins are subjected to a 25% handling fee. By siging this form, the customer agrees to authroize TPC to bill the credit card in the amount shown above plus all freight charges.

# Corporate Staff Contacts

Customer Care (8:00 a.m. – 5 p.m. PST)  
Customer Service Fax Orders

1-626-810-4337  
1-626-810-4245



**Scott Beckley**  
Vice President Sales  
sbeckley@tpcdental.com



**Mike Carlone**  
Service / Repair Manager  
mcarlone@tpcdental.com



**Holly Han**  
Shipping Manager  
holly@tpcdental.com



**Ryan Kong**  
Customer Service  
customerservice@tpcdental.com



**Alfonso Sanchez**  
Latin American Sales  
alfonso@tpcdental.com



**Charlie Chuck**  
Handpiece Specialist  
charles@tpcdental.com

**Jeff Lliscano**  
Technical Support  
jliscano@tpcdental.com

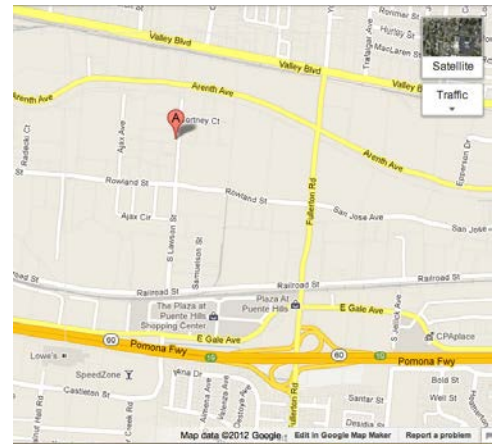

851 S. Lawson St. • City of Industry, CA  
91748  
Tel. (800) 560-8222 • Fax (626) 810-4245



# Upholstery Color Selection

## Nagua Soft Upholstery



PR 40 Black Satin



PR 51 Cocoa

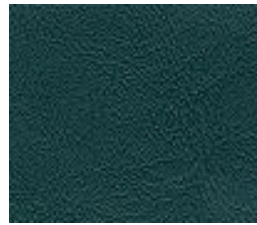

PR 49 Deep Sea



PR 44 Cream



PR 47 Tapestry Red



PR 50 Lake Louise



PR 37 Feather



PR 35 Fawn



PR 55 Deep Sapphire



PR 48 Doeskin

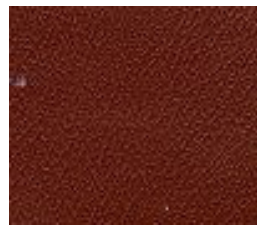

PR 38 Harness



PR 53 Ivy



PR 46 Blue Fog

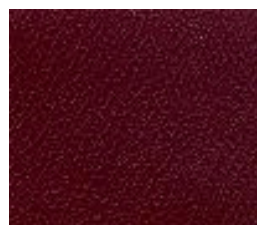

PR 36 Cabernet



PR 43 Velvet Brown



PR 54 Mallard Blue



PR 45 Mint Leaf



PR 41 Mulberry



PR 39 Laurel



PR 42 Rose Blush

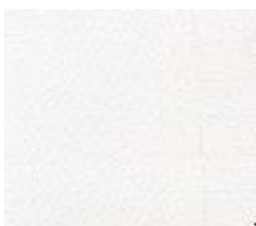

PR 34 Soft White



PR 52 Saddle

### Stocked (highlighted) Nauga Soft Upholstery Charges:

Dental Chair:	\$200.00
Assistant Stool:	\$150.00
Doctor Stool:	\$130.00

PR 37, 47, 40, 49, 50, 51

### Non-Stocked Nauga Soft Upholstery Charges:

Dental Chair:	\$450.00
Assistant Stool:	\$150.00
Doctor Stool:	\$130.00

# Upholstery Color Selection



Maive  
DU-03



Desert Rose  
DU-06



Purple Grey  
DU-07



Dusty Jade  
DU-11



Wedgewood  
DU-14



Grey Teal  
DU-15



Taupe  
DU-18



Greystone  
DU-19



Black  
DU-100



Cobalt  
DU-116



Atlantis  
DU-201



Autumn  
DU-202



Tumbleweed  
DU-210



Cinnamon  
DU-213



Stormy  
DU-220

TPC recommends final upholstery color to be selected from actual color swatch chart.



# TPC

**TPC Advanced Technology, Inc.**

851 S. Lawson St. • City of Industry, CA 91748

Tel. (800) 560-8222 • Fax (626) 810-4245

[tpcdental.com](http://tpcdental.com)